

N-channel 950 V, 3 Ω typ., 4 A MDmesh K3 Power MOSFET in a TO-220 package

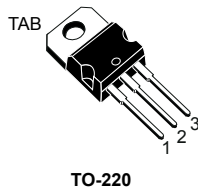

TO-220

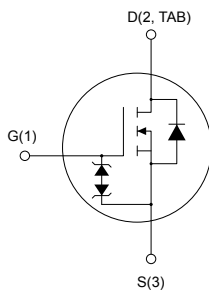

AM01476v1_tab



Product status link

[STP5N95K3](#)

Product summary

Order code	STP5N95K3
Marking	5N95K3
Package	TO-220
Packing	Tube

Features

Order code	V_{DS}	$R_{DS(on)}$ max.	I_D
STP5N95K3	950 V	3.5 Ω	4 A

- 100% avalanche tested
- Extremely high dv/dt capability
- Very low intrinsic capacitance
- Improved diode reverse recovery characteristics
- Zener-protected

Applications

- Switching applications

Description

This MDmesh K3 Power MOSFET is the result of improvements applied to STMicroelectronics' MDmesh technology, combined with a new optimized vertical structure. This device boasts an extremely low on-resistance, superior dynamic performance and high avalanche capability, rendering it suitable for the most demanding applications.

1 Electrical ratings

Table 1. Absolute maximum ratings

Symbol	Parameter	Value	Unit
V _{GS}	Gate-source voltage	±30	V
I _D	Drain current (continuous) at T _C = 25 °C	4	A
	Drain current (continuous) at T _C = 100 °C	3	
I _{DM} ⁽¹⁾	Drain current (pulsed)	16	A
P _{TOT}	Total power dissipation at T _C = 25 °C	90	W
I _{AR}	Avalanche current, repetitive or non-repetitive (pulse width limited by T _J max)	4	A
E _{AS}	Single pulse avalanche energy (starting T _J = 25 °C, I _D = I _{AR} , V _{DD} = 50 V)	100	mJ
dv/dt ⁽²⁾	Peak diode recovery voltage slope	5	V/ns
T _{stg}	Storage temperature range	-55 to 150	°C
T _J	Operating junction temperature range		°C

1. Pulse width limited by safe operating area.

2. $I_{SD} \leq 4 \text{ A}$, $di/dt \leq 100 \text{ A}/\mu\text{s}$, $V_{DS} (\text{peak}) \leq V_{(BR)DSS}$.

Table 2. Thermal data

Symbol	Parameter	Value	Unit
R _{thJC}	Thermal resistance, junction-to-case	1.39	°C/W
R _{thJA}	Thermal resistance, junction-to-ambient	62.5	°C/W

2 Electrical characteristics

$T_C = 25\text{ °C}$ unless otherwise specified.

Table 3. On/off states

Symbol	Parameter	Test conditions	Min.	Typ.	Max.	Unit
$V_{(BR)DSS}$	Drain-source breakdown voltage	$I_D = 1\text{ mA}$, $V_{GS} = 0\text{ V}$	950			V
I_{DSS}	Zero gate voltage drain current	$V_{GS} = 0\text{ V}$, $V_{DS} = 950\text{ V}$			1	μA
		$V_{GS} = 0\text{ V}$, $V_{DS} = 950\text{ V}$, $T_C = 125\text{ °C}$ ⁽¹⁾			50	
I_{GSS}	Gate body leakage current	$V_{GS} = \pm 20\text{ V}$, $V_{DS} = 0\text{ V}$			± 10	μA
$V_{GS(th)}$	Gate threshold voltage	$V_{DS} = V_{GS}$, $I_D = 100\text{ }\mu\text{A}$	3	4	5	V
$R_{DS(on)}$	Static drain-source on-resistance	$V_{GS} = 10\text{ V}$, $I_D = 2\text{ A}$		3	3.5	Ω

1. Specified by design, not tested in production.

Table 4. Dynamic

Symbol	Parameter	Test conditions	Min.	Typ.	Max.	Unit
C_{iss}	Input capacitance	$V_{DS} = 25\text{ V}$, $f = 1\text{ MHz}$, $V_{GS} = 0\text{ V}$	-	460	-	pF
C_{oss}	Output capacitance		-	38	-	pF
C_{riss}	Reverse transfer capacitance		-	1	-	pF
$C_{o(tr)}$ ⁽¹⁾	Equivalent output capacitance time related	$V_{GS} = 0\text{ V}$, $V_{DS} = 0\text{ to }760\text{ V}$	-	970	-	pF
$C_{o(er)}$ ⁽²⁾	Equivalent output capacitance energy related		-	15	-	pF
R_g	Intrinsic gate resistance	$f = 1\text{ MHz}$, $I_D = 0\text{ A}$	-	5.5	-	Ω
Q_g	Total gate charge	$V_{DD} = 760\text{ V}$, $I_D = 4\text{ A}$, $V_{GS} = 0\text{ to }10\text{ V}$ (see Figure 15. Test circuit for gate charge behavior)	-	19	-	nC
Q_{gs}	Gate-source charge		-	4.7	-	nC
Q_{gd}	Gate-drain charge		-	12	-	nC

1. $C_{o(tr)}$ is a constant capacitance value that gives the same charging time as C_{oss} while V_{DS} is rising from 0 to 80% V_{DSS} .

2. $C_{o(er)}$ is a constant capacitance value that gives the same stored energy as C_{oss} while V_{DS} is rising from 0 to 80% V_{DSS} .

Table 5. Switching times

Symbol	Parameter	Test conditions	Min.	Typ.	Max.	Unit
$t_{d(on)}$	Turn-on delay time	$V_{DD} = 475\text{ V}$, $I_D = 2\text{ A}$, $R_G = 4.7\text{ }\Omega$, $V_{GS} = 10\text{ V}$ (see Figure 14. Test circuit for resistive load switching times and Figure 19. Switching time waveform)	-	17	-	ns
t_r	Rise time		-	7	-	ns
$t_{d(off)}$	Turn-off delay time		-	32	-	ns
t_f	Fall time		-	18	-	ns

Table 6. Source-drain diode

Symbol	Parameter	Test conditions	Min.	Typ.	Max.	Unit
I_{SD}	Source-drain current		-		4	A
$I_{SDM}^{(1)}$	Source-drain current (pulsed)		-		16	A
$V_{SD}^{(2)}$	Forward on voltage	$I_{SD} = 4 \text{ A}, V_{GS} = 0 \text{ V}$	-		1.6	V
t_{rr}	Reverse recovery time	$I_{SD} = 4 \text{ A}, di/dt = 100 \text{ A}/\mu\text{s}, V_{DD} = 60 \text{ V}$	-	410		ns
Q_{rr}	Reverse recovery charge	(see Figure 16. Test circuit for inductive load switching and diode recovery times)	-	3.5		μC
I_{RRM}	Reverse recovery current		-	17		A
t_{rr}	Reverse recovery time	$I_{SD} = 4 \text{ A}, di/dt = 100 \text{ A}/\mu\text{s}, V_{DD} = 60 \text{ V},$	-	516		ns
Q_{rr}	Reverse recovery charge	$T_J = 150 \text{ }^\circ\text{C}$ (see Figure 16. Test circuit for inductive load switching and diode recovery times)	-	4.1		μC
I_{RRM}	Reverse recovery current		-	16		A

1. Pulse width limited by safe operating area.
2. Pulsed: pulse duration = 300 μs , duty cycle 1.5%.

2.1 Electrical characteristics (curves)

Figure 1. Safe operating area

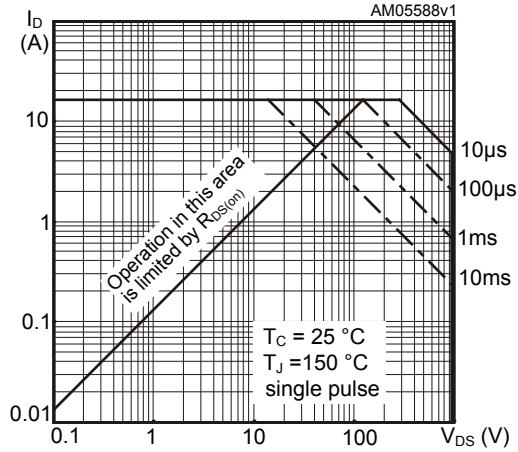

Figure 2. Normalized transient thermal impedance

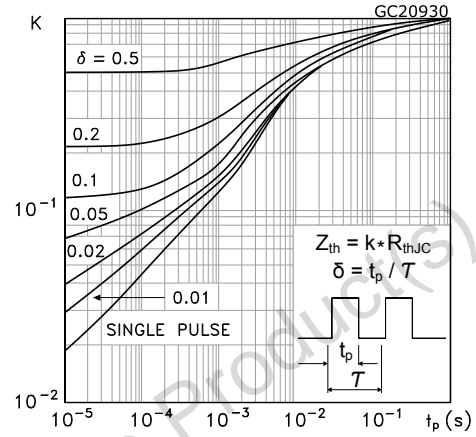

Figure 3. Typical output characteristics

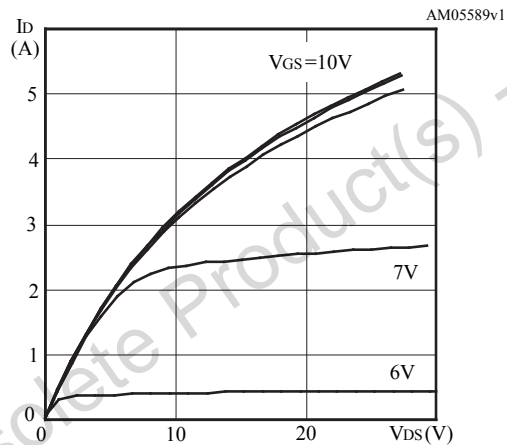

Figure 4. Typical transfer characteristics

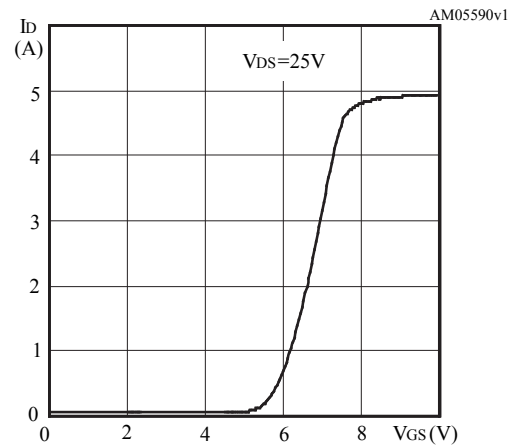

Figure 5. Typical gate charge characteristics

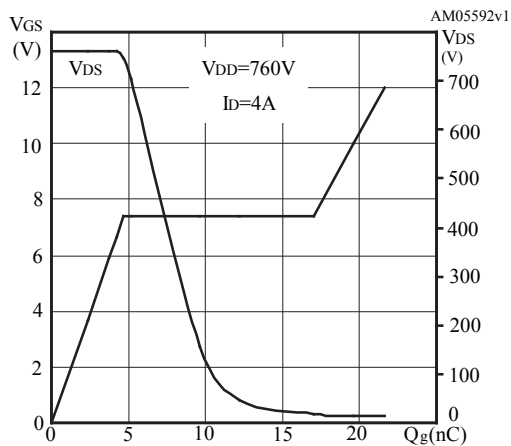

Figure 6. Typical drain-source on-resistance

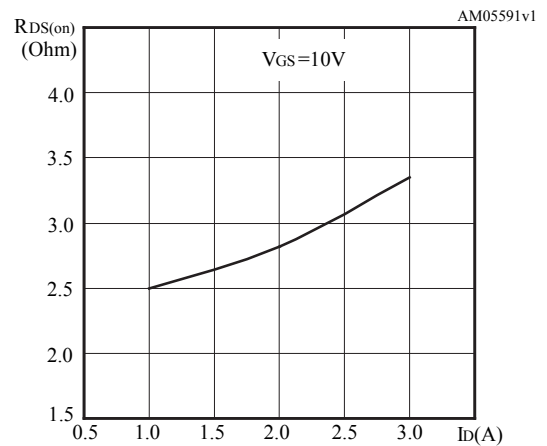

Figure 7. Typical capacitance characteristics

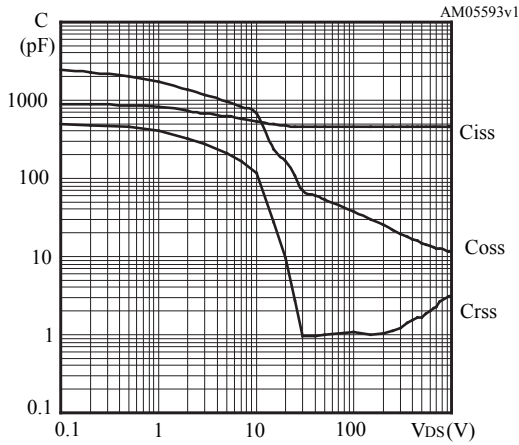

Figure 8. Typical output capacitance stored energy

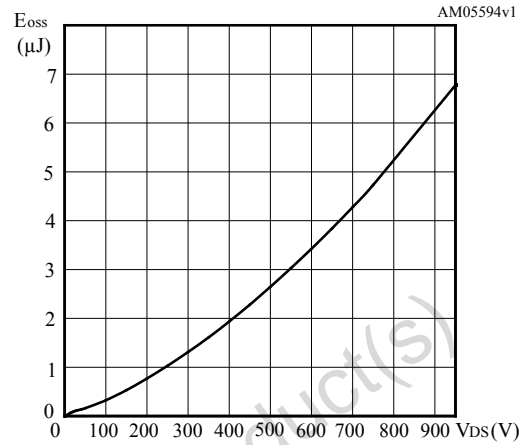

Figure 9. Normalized gate threshold vs temperature

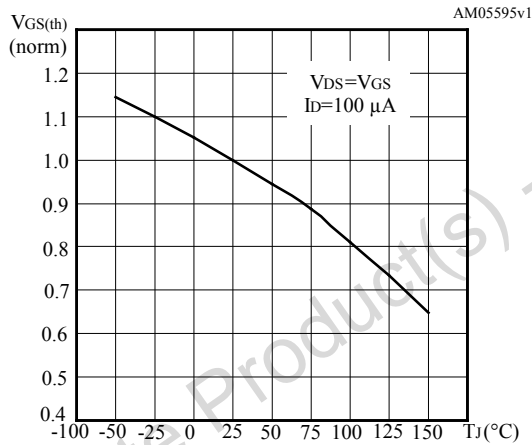

Figure 10. Normalized on-resistance vs temperature

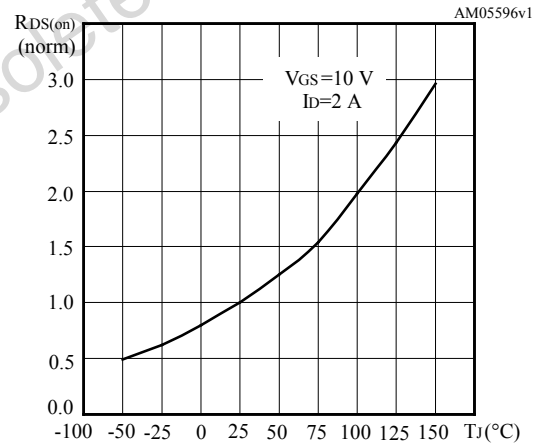

Figure 11. Normalized breakdown voltage vs temperature

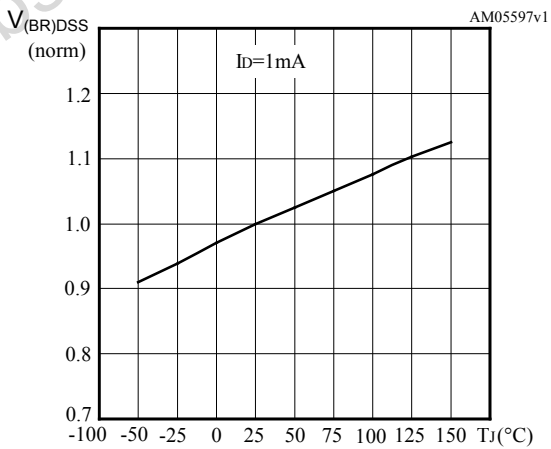

Figure 12. Typical reverse diode forward characteristics

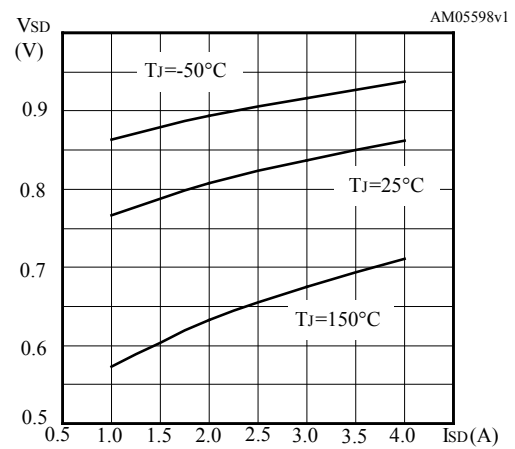
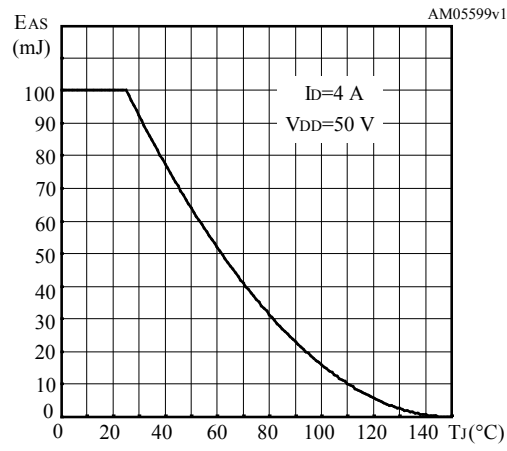
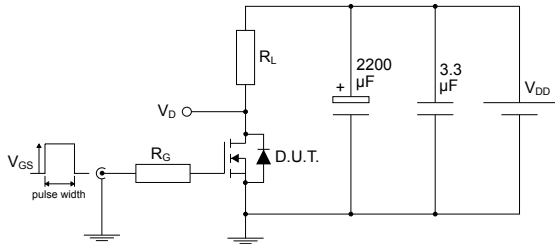

Figure 13. Maximum avalanche energy vs temperature



Obsolete Product(s) - Obsolete Product(s)

3 Test circuits

Figure 14. Test circuit for resistive load switching times

AM01468v1

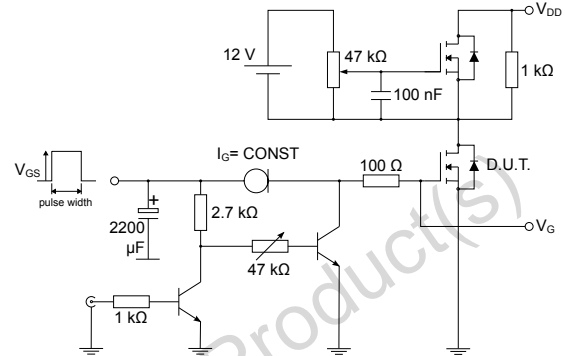
Figure 15. Test circuit for gate charge behavior

AM01469v1

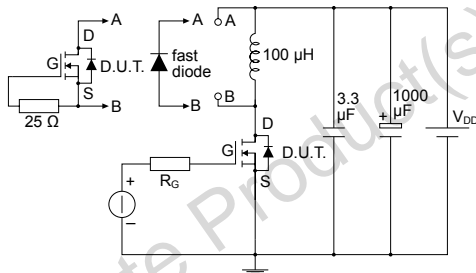
Figure 16. Test circuit for inductive load switching and diode recovery times

AM01470v1

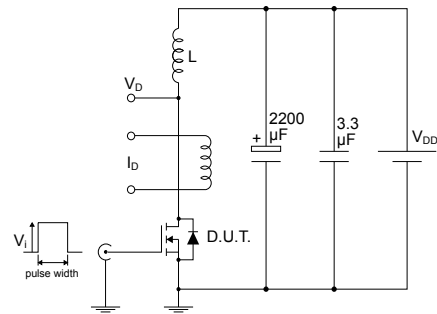
Figure 17. Unclamped inductive load test circuit

AM01471v1

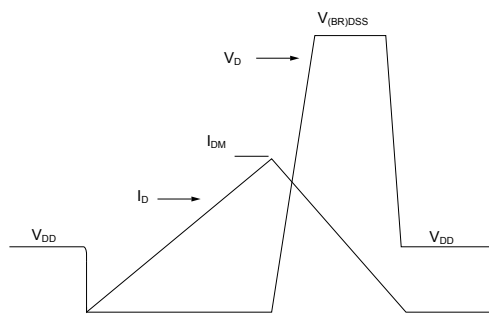
Figure 18. Unclamped inductive waveform

AM01472v1

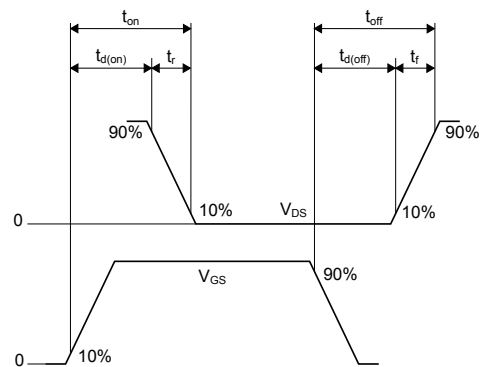
Figure 19. Switching time waveform

AM01473v1

4 Package information

In order to meet environmental requirements, ST offers these devices in different grades of **ECOPACK** packages, depending on their level of environmental compliance. ECOPACK specifications, grade definitions and product status are available at: www.st.com. ECOPACK is an ST trademark.

4.1 TO-220 type A package information

Figure 20. TO-220 type A package outline

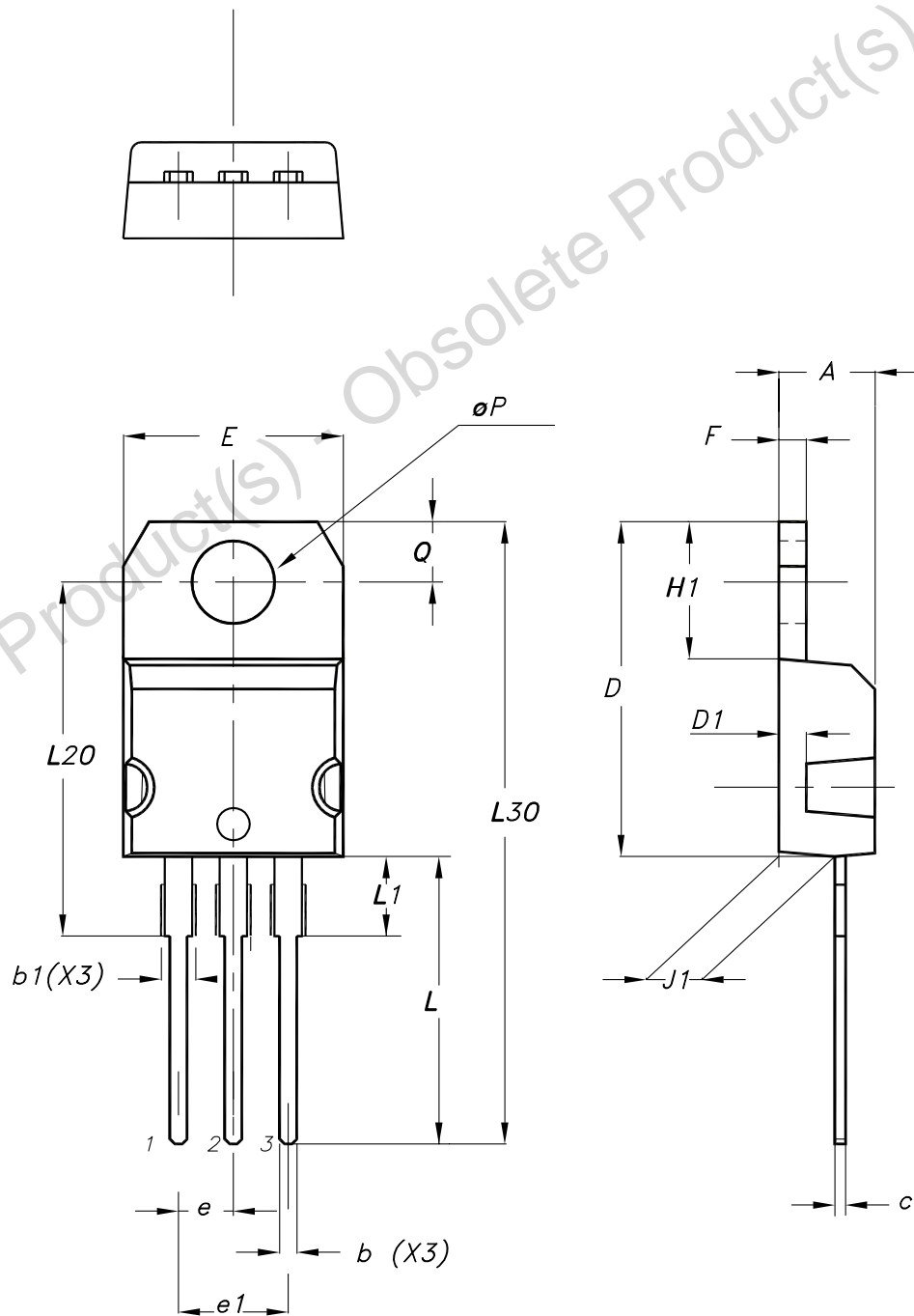

0015988_typeA_Rev_23

Table 7. TO-220 type A package mechanical data

Dim.	mm		
	Min.	Typ.	Max.
A	4.40		4.60
b	0.61		0.88
b1	1.14		1.55
c	0.48		0.70
D	15.25		15.75
D1		1.27	
E	10.00		10.40
e	2.40		2.70
e1	4.95		5.15
F	1.23		1.32
H1	6.20		6.60
J1	2.40		2.72
L	13.00		14.00
L1	3.50		3.93
L20		16.40	
L30		28.90	
øP	3.75		3.85
Q	2.65		2.95
Slug flatness		0.03	0.10

Revision history

Table 8. Document revision history

Date	Version	Changes
09-May-2023	1	First release. Part number previously included in datasheet DS6265.

Obsolete Product(s) - Obsolete Product(s)

Contents

1	Electrical ratings	2
2	Electrical characteristics	3
2.1	Electrical characteristics (curves)	5
3	Test circuits	8
4	Package information	9
4.1	TO-220 type A package information	9
	Revision history	11

Obsolete Product(s) - Obsolete Product(s)

IMPORTANT NOTICE – READ CAREFULLY

STMicroelectronics NV and its subsidiaries (“ST”) reserve the right to make changes, corrections, enhancements, modifications, and improvements to ST products and/or to this document at any time without notice. Purchasers should obtain the latest relevant information on ST products before placing orders. ST products are sold pursuant to ST’s terms and conditions of sale in place at the time of order acknowledgment.

Purchasers are solely responsible for the choice, selection, and use of ST products and ST assumes no liability for application assistance or the design of purchasers’ products.

No license, express or implied, to any intellectual property right is granted by ST herein.

Resale of ST products with provisions different from the information set forth herein shall void any warranty granted by ST for such product.

ST and the ST logo are trademarks of ST. For additional information about ST trademarks, refer to www.st.com/trademarks. All other product or service names are the property of their respective owners.

Information in this document supersedes and replaces information previously supplied in any prior versions of this document.

© 2023 STMicroelectronics – All rights reserved

Obsolete Product(s) - Obsolete Product(s)