

**8 A(12 A<sub>r.m.s.</sub>) THYRISTOR**

**PACKAGE DIMENSIONS**  
in millimeters

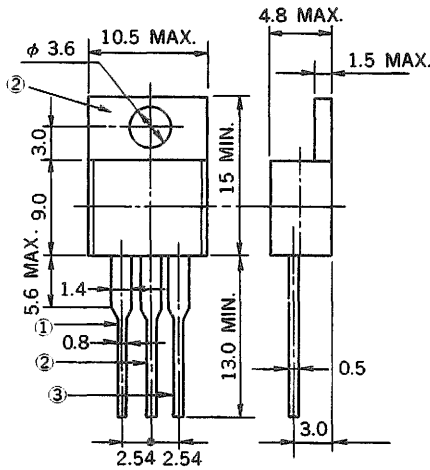

**Pin Connection**  
 ① Cathode  
 ② Anode  
 ③ Gate

The 8P2M and 8P4M are P gate all diffused mold type Thyristor granted 8 Amp On-state Average Current ( $T_c = 90^\circ\text{C}$ ), with voltages up to 400 volts.

**FEATURES**

- Easy installation by TO-220 AB package.
- 100 A surge current.
- High Voltage.
  - :  $V_{DRM}, V_{RRM} = 200\text{ V}$  (8P2M)
  - :  $V_{DRM}, V_{RRM} = 400\text{ V}$  (8P4M)

**APPLICATIONS**

- Motor speed control for household appliance.
- Temperature control for heater and constant temperature box.
- Constant voltage power source and battery charger.
- Automotive application such as regulator.
- Various solid state relay etc.

**MAXIMUM RATINGS**

CHARACTERISTIC	SYMBOL	8P2M	8P4M	UNIT	NOTE
Non-Repetitive Peak Reverse Voltage	$V_{RSM}$	300	500	V	
Non-Repetitive Peak Off-State Voltage	$V_{DSM}$	300	500	V	
Repetitive Peak Reverse Voltage	$V_{RRM}$	200	400	V	
Repetitive Peak Off-State Voltage	$V_{DRM}$	200	400	V	
Average On-State Current	$I_{T(AV)}$	8 ( $T_c = 90^\circ\text{C}, \theta = 180^\circ$ Single phase half wave)		A	See Fig. 11
Surge On-State Current	$I_{TSM}$	100		A	See Fig. 2
Fusing Current	$\int i_T^2 dt$	45 ( $1\text{ ms} \leq t \leq 10\text{ ms}$ )		$\text{A}^2\text{s}$	
Peak Gate Power Dissipation	$P_{GM}$	5 ( $f \geq 50\text{ Hz}, \text{Duty} \leq 10\%$ )		W	See Fig. 3
Average Gate Power Dissipation	$P_{G(AV)}$	0.5		W	
Peak Gate Forward Current	$I_{FGM}$	2 ( $f \geq 50\text{ Hz}, \text{Duty} \leq 10\%$ )		A	
Peak Gate Reverse Voltage	$V_{RGM}$	10		V	
Junction Temperature	$T_j$	-40 to +125		$^\circ\text{C}$	
Storage Temperature	$T_{stg}$	-55 to +150		$^\circ\text{C}$	
Weight		2		g	

NEC cannot assume any responsibility for any circuits shown or represent that they are free from patent infringement.

ELECTRICAL CHARACTERISTICS ( $T_j = 25^\circ\text{C}$ )

CHARACTERISTIC	SYMBOL	CONDITION	MIN.	TYP.	MAX.	UNIT	NOTE
Repetitive Peak Reverse Current	$I_{RRM}$	$V_{RM} = V_{RRM}, T_j = 125^\circ\text{C}$	—	—	2	mA	
Repetitive Peak Off-State Current	$I_{DRM}$	$V_{DM} = V_{DRM}, T_j = 125^\circ\text{C}$	—	—	2	mA	
On-State Voltage	$V_{TM}$	$I_{TM} = 25\text{ A}$	—	—	1.4	V	See Fig. 1
Gate-Trigger Current	$I_{GT}$	$V_{DM} = 6\text{ V}, R_L = 100\ \Omega$	—	—	10	mA	See Fig. 4
Gate-Trigger Voltage	$V_{GT}$	$V_{DM} = 6\text{ V}, R_L = 100\ \Omega$	—	—	1.5	V	
Gate Non-Trigger Voltage	$V_{GD}$	$V_{DM} = 1/2 V_{DRM}, T_j = 125^\circ\text{C}$	0.2	—	—	V	
Critical Rate of Rise of Off-State Voltage	$dv/dt$	$V_{DM} = V_{DRM}, T_j = 125^\circ\text{C}$	—	40	—	V/ $\mu\text{s}$	
Holding Current	$I_H$	$V_D = 24\text{ V}$	—	6	—	mA	
Circuit Commuted Turn-Off Time	$t_d$	$I_{TM} = 5\text{ A}, V_R \geq 25\text{ V}$ $V_{DM} = 2/3 V_{DRM}, diR/dt = 15\text{ A}/\mu\text{s}$ $dv/dt = 10\text{ V}/\mu\text{s}, T_j = 125^\circ\text{C}$	—	100	—	$\mu\text{s}$	
Thermal Resistance	$R_{th}$	Junction to case	—	—	3	$^\circ\text{C}/\text{W}$	See Fig. 13

Fig. 1  $i_T - V_T$  CHARACTERISTIC

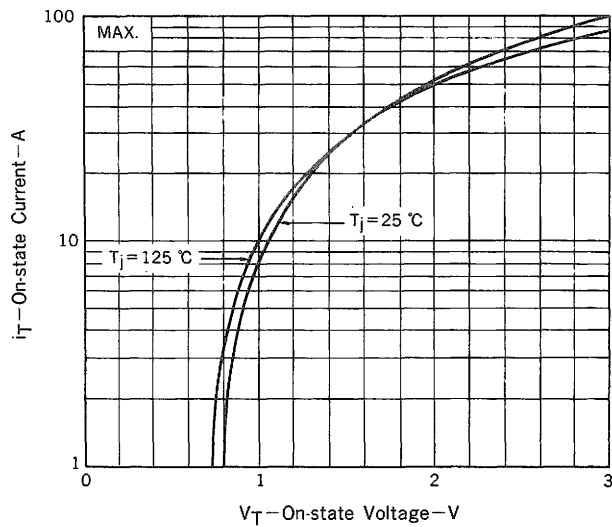

Fig. 2  $I_{TSM}$  RATING

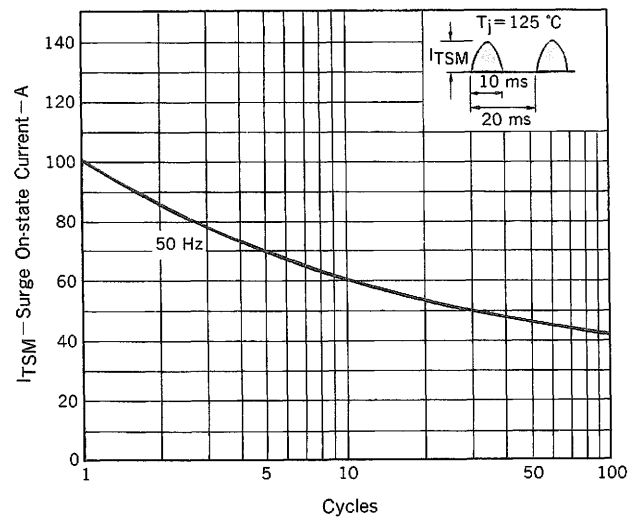

Fig. 3 GATE POWER RATING

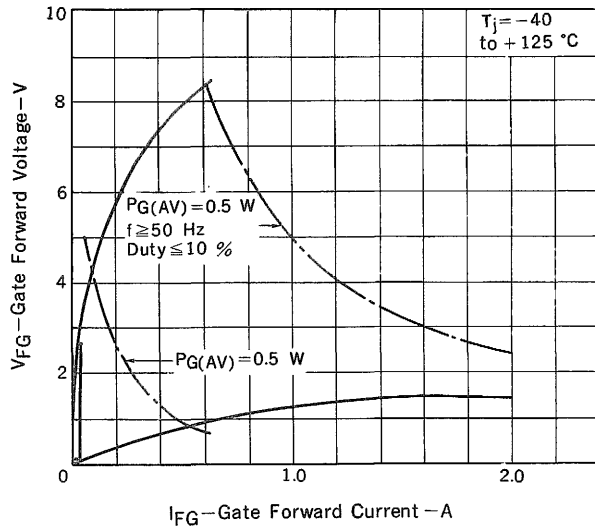

Fig. 4  $I_{GT} - V_{GT}$  DISTRIBUTION

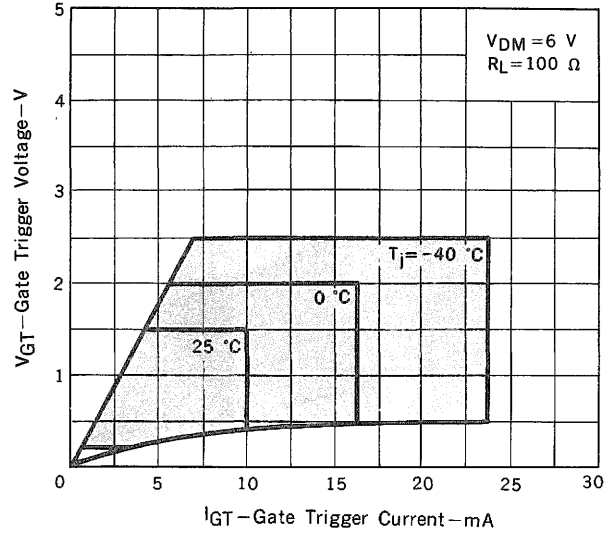

Fig. 5  $I_{GT} - T_a$  TYPICAL DISTRIBUTION

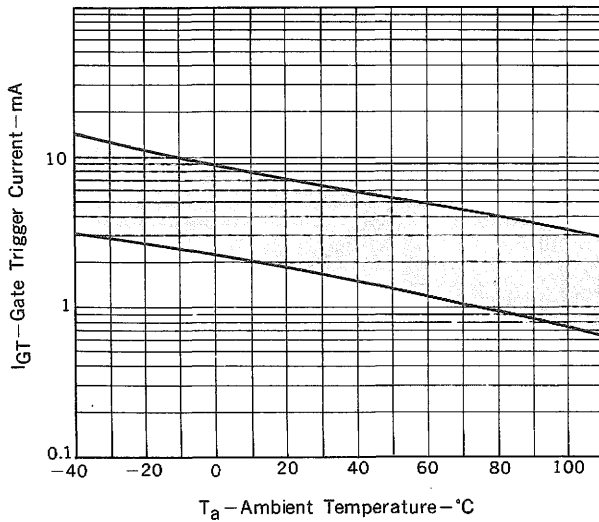

Fig. 6  $V_{GT} - T_a$  TYPICAL DISTRIBUTION

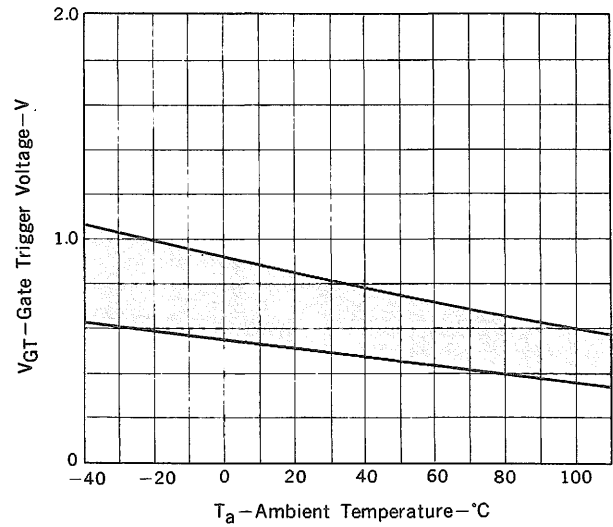

Fig. 7  $i_{GS} - \tau_G$  TYPICAL DISTRIBUTION

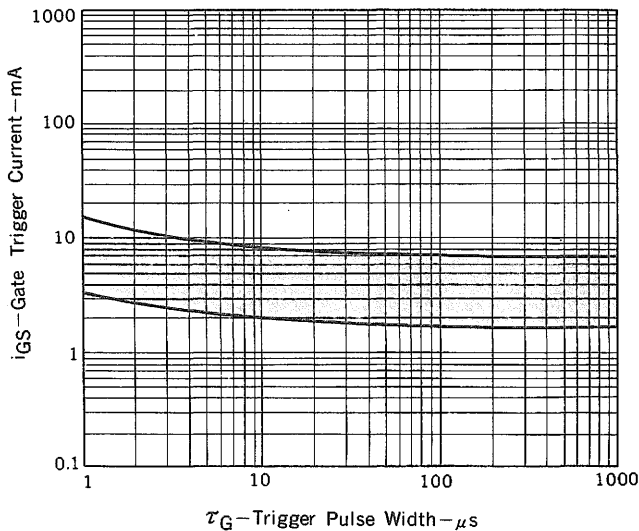

Fig. 8  $V_{GT} - \tau_G$  TYPICAL DISTRIBUTION

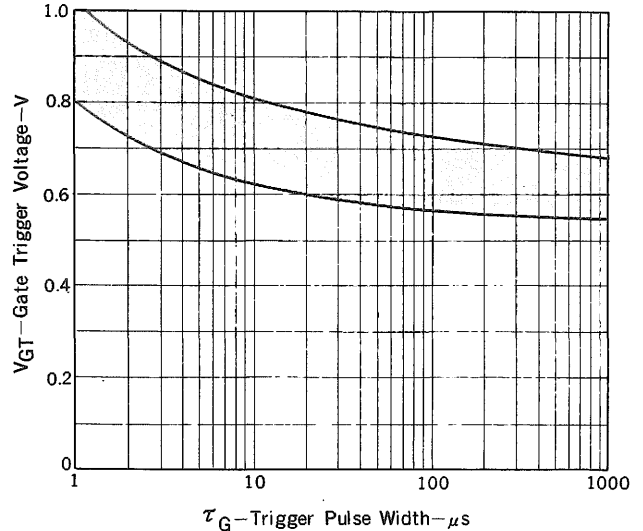

Fig. 9  $I_H - T_a$  TYPICAL DISTRIBUTION

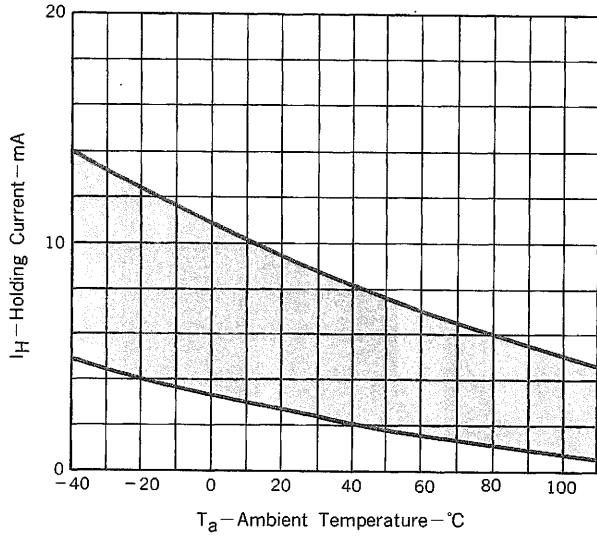

Fig. 10  $P_{T(AV)} - I_{T(AV)}$  CHARACTERISTICS

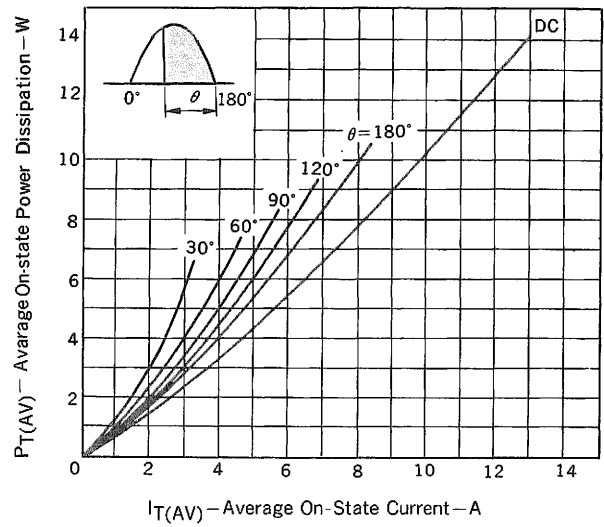

Fig. 11  $T_c - I_{T(AV)}$  RATING

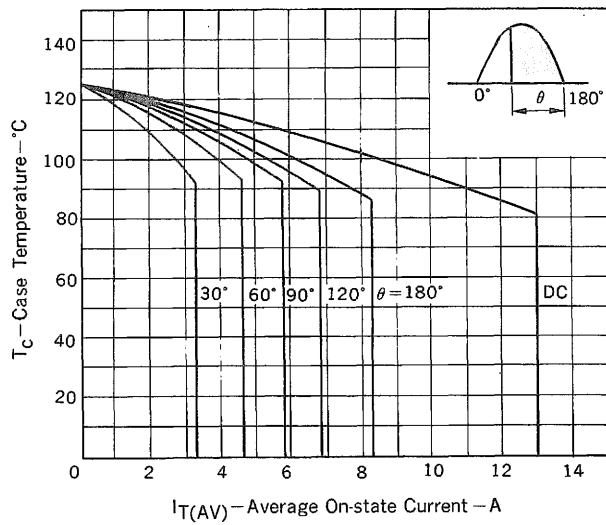

Fig. 12  $T_a - I_{T(AV)}$  RATING

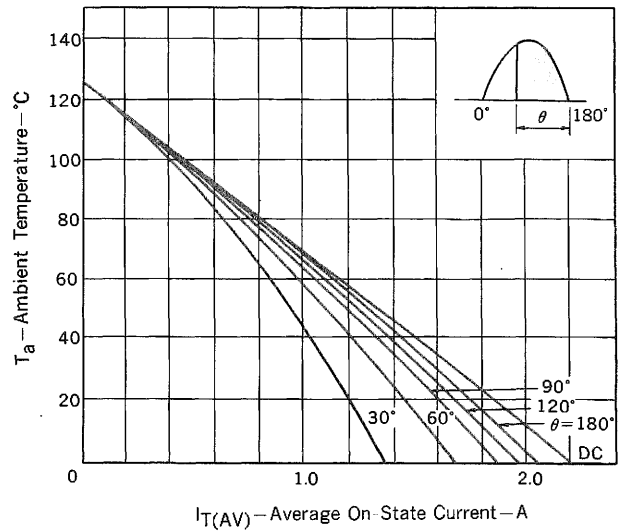

Fig. 13  $Z_{th}$  CHARACTERISTICS

