

### 描述 / Descriptions

SOT-23 塑封封装 N 道 MOS 场效应管。N- CHANNEL MOSFET in a SOT-23 Plastic Package.

### 特征 / Features

$V_{DS} (V) = 30V$

$I_D = 5.8 A (V_{GS} = 10V)$

$R_{DS(ON)} < 28m\Omega (V_{GS} = 10V)$

$R_{DS(ON)} < 33m\Omega (V_{GS} = 4.5V)$

$R_{DS(ON)} < 52m\Omega (V_{GS} = 2.5V)$

### 用途 / Applications

适用于作负载开关或脉宽调制应用。

This device is suitable for use as a load switch or in PWM applications.

### 内部等效电路 / Equivalent Circuit

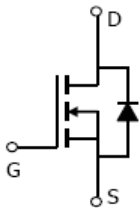

### 引脚排列 / Pinning



PIN 1 : S

PIN 2 : G

PIN 3 : D

### 印章代码 / Marking

Marking	A0H
---------	-----

**极限参数 / Absolute Maximum Ratings(Ta=25°C)**

参数 Parameter	符号 Symbol	数值 Rating	单位 Unit
Drain-Source Voltage	$V_{DS}$	30	V
Drain Current – Continuous	$I_D$	5.8	A
Drain Current- Continuous	$I_D(T_a=70^\circ\text{C})$	4.9	A
Pulsed Drain Current	$I_{DM}$	30	A
Gate-Source Voltage	$V_{GS}$	$\pm 12$	V
Total Power Dissipation	$P_D$	1.4	W
Total Power Dissipation	$P_D(T_a=70^\circ\text{C})$	1.0	W
Operating and Storage Junction Temperature Range	$T_J, T_{STG}$	-55 to 150	$^\circ\text{C}$

**电性能参数 / Electrical Characteristics(Ta=25°C)**

参数 Parameter	符号 Symbol	测试条件 Test Conditions	最小值 Min	典型值 Typ	最大值 Max	单位 Unit
Drain–Source Breakdown Voltage	$BV_{DSS}$	$V_{GS}=0V$ $I_D=250\mu A$	30			V
Zero Gate Voltage Drain Current	$I_{DSS}$	$V_{DS}=24V$ $V_{GS}=0V$			1	$\mu A$
		$V_{DS}=24V$ $V_{GS}=0V$ $T_J=55^\circ\text{C}$			5	$\mu A$
Gate–Body Leakage.	$I_{GSS}$	$V_{GS}=\pm 12V$ $V_{DS}=0V$			$\pm 0.1$	$\mu A$
On–State Drain Current	$I_{D(on)}$	$V_{GS}=4.5V$ $V_{DS}=5V$	30			A
Gate Threshold Voltage	$V_{GS(th)}$	$V_{DS}=V_{GS}$ $I_D=250\mu A$	0.7	1.1	1.4	V
Static Drain–Source On–Resistance	$R_{DS(on)(1)}$	$V_{GS}=10V$ $I_D=5.8A$		22.8	28	m $\Omega$
	$R_{DS(on)(2)}$	$V_{GS}=10V$ $I_D=5.8A$ $T_J=125^\circ\text{C}$		32	39	
	$R_{DS(on)(3)}$	$V_{GS}=4.5V$ $I_D=5A$		27.3	33	
	$R_{DS(on)(4)}$	$V_{GS}=2.5V$ $I_D=4A$		43.3	52	
Forward Transconductance	$g_{FS}$	$V_{DS}=5V$ $I_D=5A$	10	15		S
Drain–Source Diode Forward Voltage	$V_{SD}$	$V_{GS}=0V$ $I_S=1A$		0.77	1	V
Input Capacitance	$C_{iss}$	$V_{DS}=15V$ $V_{GS}=0V$ $f=1\text{MHz}$		823	1030	pF
Output Capacitance	$C_{oss}$			99		
Reverse Transfer Capacitance	$C_{rss}$			77		
Turn–On Delay Time	$t_{d(on)}$	$V_{GS}=10V$ $R_L=2.7\Omega$ $V_{DS}=15V$ $R_{GEN}=3\Omega$		3.3	5	ns
Turn–On Rise Time	$t_r$			4.8	7	
Turn–Off Delay Time	$t_{d(off)}$			26.3	40	
Turn–Off Fall Time	$t_f$			4.1	6	

**电参数曲线图 / Electrical Characteristic Curve**

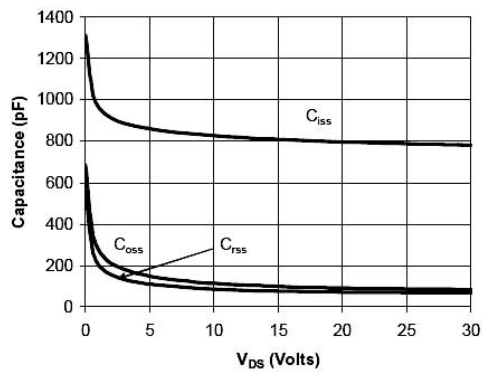
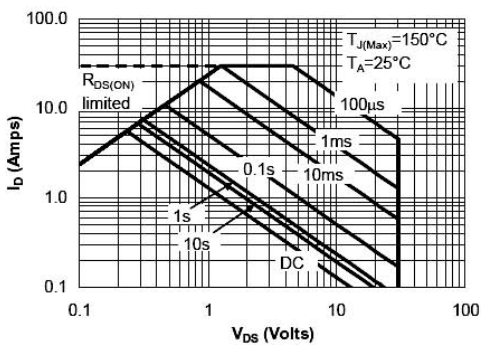
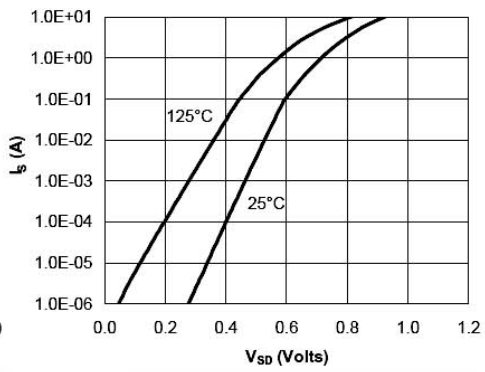
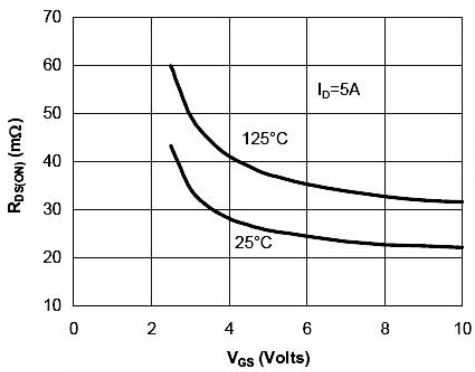
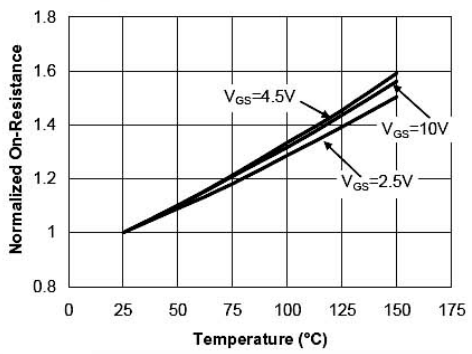
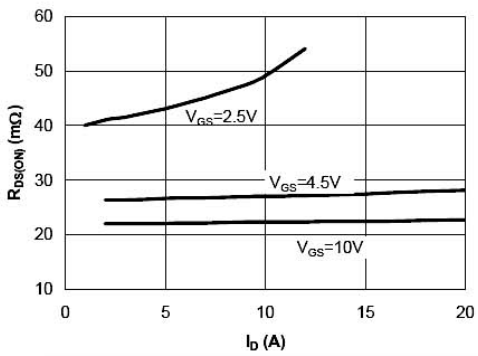
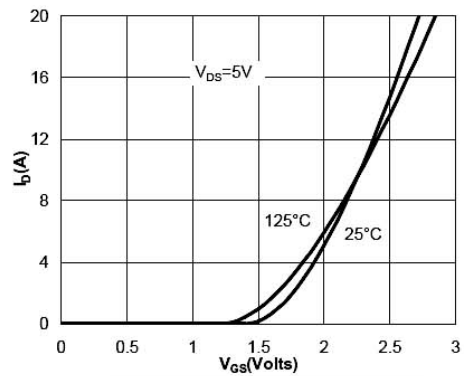
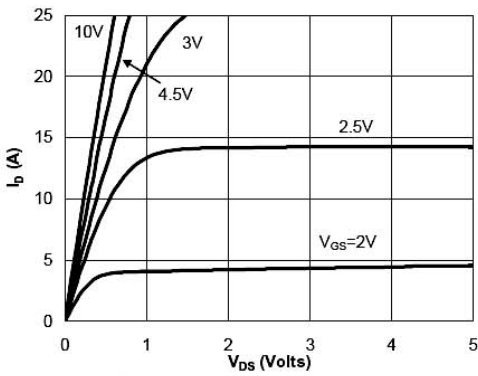

外形尺寸图 / Package Dimensions

SOT-23

单位: mm

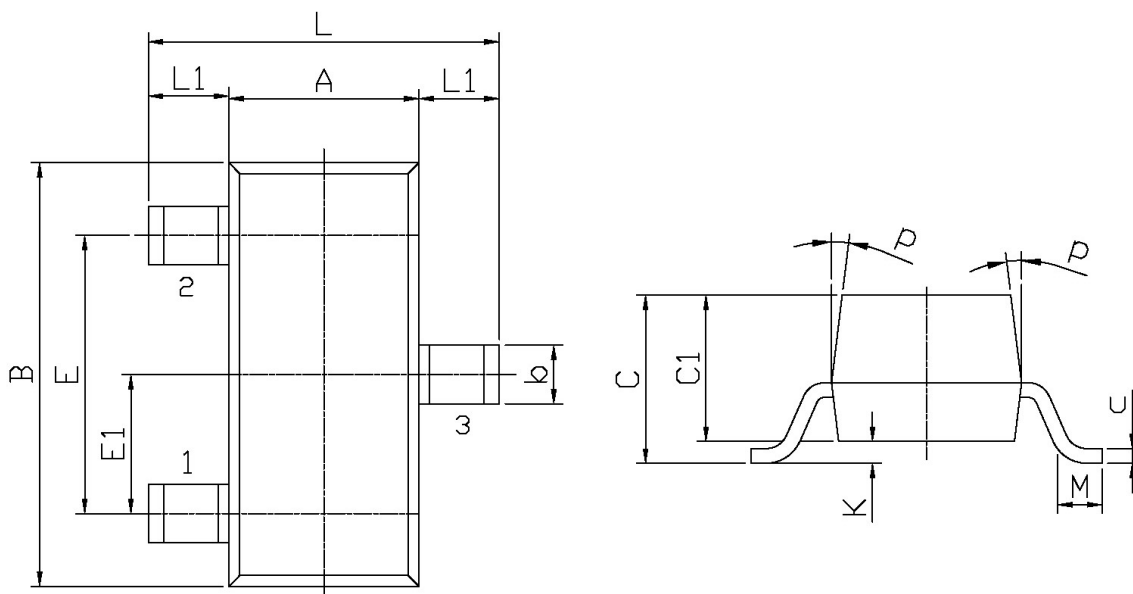

Symbol	Dimensions In Millimeters		Symbol	Dimensions In Millimeters	
	Min	Max		Min	Max
L	2.2	2.7	C	1.30Max	
L1	0.45	0.65	C1	0.90	1.20
A	1.15	1.50	c	0.05	0.20
B	2.70	3.10	K	0	0.10
E	1.70	2.10	M	0.20MIN	
E1	0.85	1.05	P	7°	
b	0.35	0.55			

印章说明 / Marking Instructions

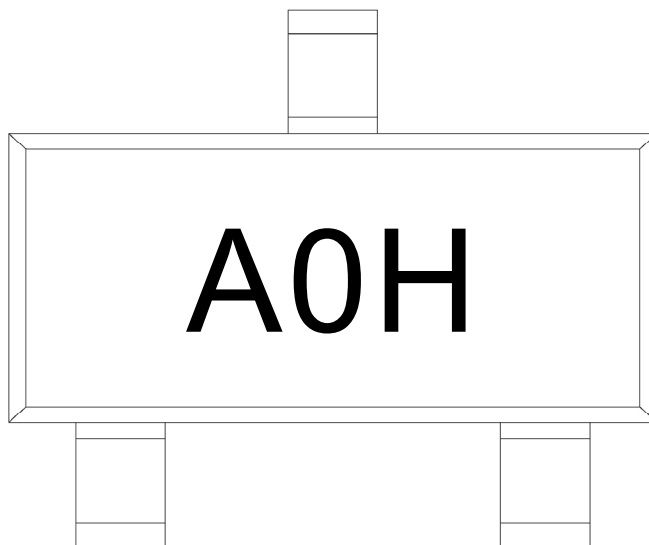

说明：

A0： 为型号代码

H： 为公司代码

Note:

A0: Product Type Code.

H: Company Code.

**回流焊温度曲线图(无铅) / Temperature Profile for IR Reflow Soldering(Pb-Free)**

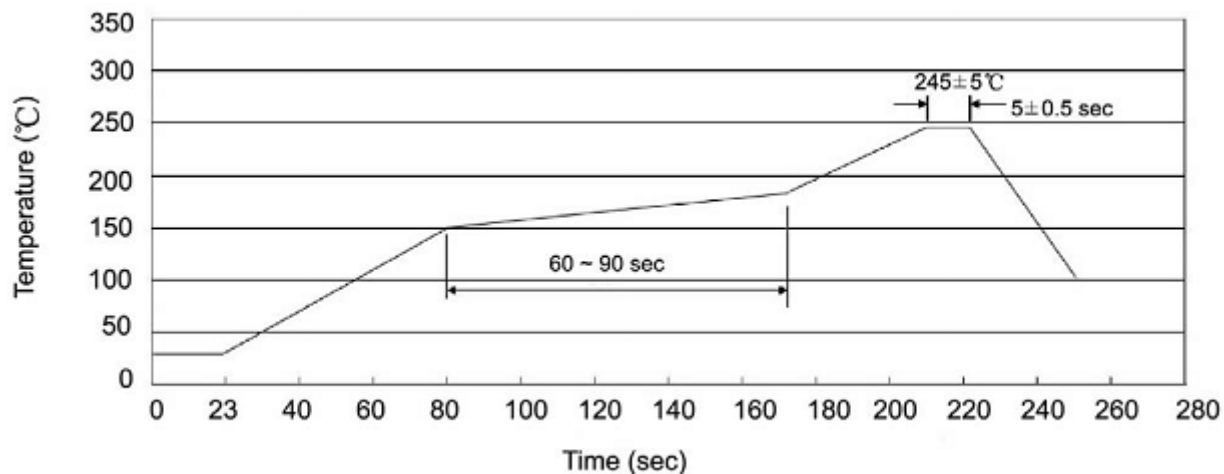

说明：

- 1、预热温度 25 ~ 150°C，时间 60 ~ 90sec;
- 2、峰值温度 245±5°C，时间持续为 5±0.5sec;
- 3、焊接制程冷却速度为 2 ~ 10°C/sec.

Note:

- 1.Preheating:25~150°C, Time:60~90sec.
- 2.Peak Temp.:245±5°C, Duration:5±0.5sec.
3. Cooling Speed: 2~10°C/sec.

**耐焊接热试验条件 / Resistance to Soldering Heat Test Conditions**

温度：260±5°C

时间：10±1 sec.

Temp.:260±5°C

Time:10±1 sec

**包装规格 / Packaging SPEC.**

卷盘包装 / REEL

Package Type 封装形式	Units 包装数量					Dimension 包装尺寸 (unit: mm <sup>3</sup> )		
	Units/Reel 只/卷盘	Reels/Inner Box 卷盘/盒	Units/Inner Box 只/盒	Inner Boxes/Outer Box 盒/箱	Units/Outer Box 只/箱	Reel	Inner Box 盒	Outer Box 箱
SOT-23	3,000	10	30,000	8	240,000	7" ×8	180×120×180	385×257×392

**使用说明 / Notices**