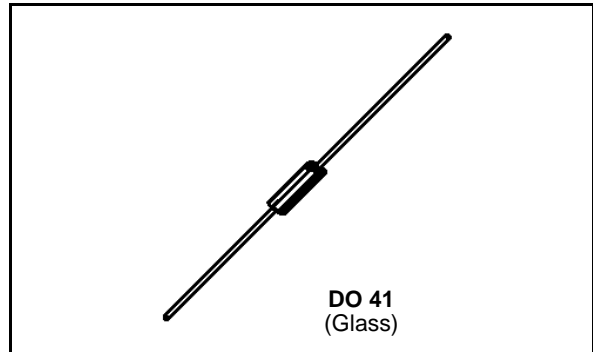

**SMALL SIGNAL SCHOTTKY DIODE****DESCRIPTION**

Metal to silicon rectifier diode in glass case featuring very low forward voltage drop and fast recovery time, intended for low voltage switching mode power supply, polarity protection and high frequency circuits.

**ABSOLUTE RATINGS** (limiting values)

Symbol	Parameter	Value	Unit
V_{RRM}	Repetitive Peak Reverse Voltage	60	V
$I_{F(AV)}$	Average Forward Current*	$T_{amb} = 25^{\circ}C$ 1	A
I_{FSM}	Surge non Repetitive Forward Current	$T_{amb} = 25^{\circ}C$ $t_p = 10ms$ 20 Sinusoidal Pulse	A
		$T_{amb} = 25^{\circ}C$ $t_p = 300\mu s$ 40 Rectangular Pulse	
T_{stg} T_j	Storage and Junction Temperature Range	- 65 to + 150 - 65 to + 125	$^{\circ}C$ $^{\circ}C$
T_L	Maximum Lead Temperature for Soldering during 10s at 4mm from Case	230	$^{\circ}C$

THERMAL RESISTANCE

Symbol	Test Conditions	Value	Unit
$R_{th(j-a)}$	Junction-ambient*	110	$^{\circ}C/W$

* On infinite heatsink with 4mm lead length

ELECTRICAL CHARACTERISTICS

STATIC CHARACTERISTICS

Symbol	Test Conditions		Min.	Typ.	Max.	Unit
I_R^*	$T_j = 25^\circ\text{C}$	$V_R = V_{RRM}$			0.5	mA
	$T_j = 100^\circ\text{C}$				10	
V_F^*	$I_F = 1\text{A}$	$T_j = 25^\circ\text{C}$			0.7	V
	$I_F = 3\text{A}$				1	

DYNAMIC CHARACTERISTICS

Symbol	Test Conditions		Min.	Typ.	Max.	Unit
C	$T_j = 25^\circ\text{C}$	$V_R = 0$		150		pF
	$T_j = 25^\circ\text{C}$	$V_R = 5\text{V}$		40		

* Pulse test: $t_p \leq 300\mu\text{s}$ $\delta < 2\%$.

Forward current flow in a schottky rectifier is due to majority carrier conduction. So reverse recovery is not affected by stored charge as in conventional PN junction diodes.

Nevertheless, when the device switches from forward biased condition to reverse blocking state, current is required to charge the depletion capacitance of the diode.

This current depends only of diode capacitance and external circuit impedance. Satisfactory circuit behaviour analysis may be performed assuming that schottky rectifier consists of an ideal diode in parallel with a variable capacitance equal to the junction capacitance (see fig. 5 page 4/4).

Figure 1. Forward current versus forward voltage at low level (typical values).

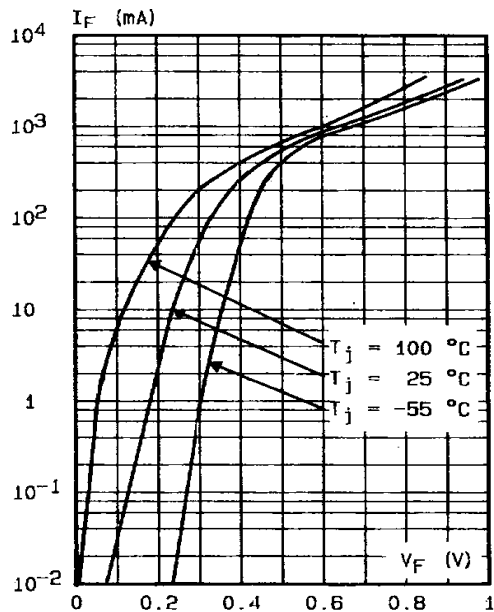

Figure 2. Forward current versus forward voltage at high level (typical values).

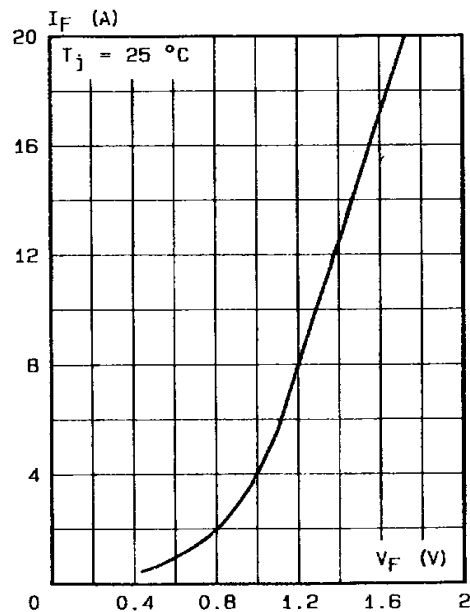

Figure 3. Reverse current versus junction temperature.

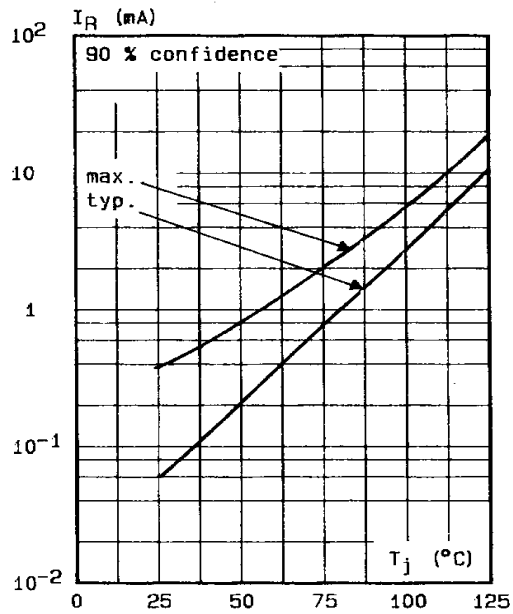

Figure 4. Reverse current versus V_{RRM} in per cent.

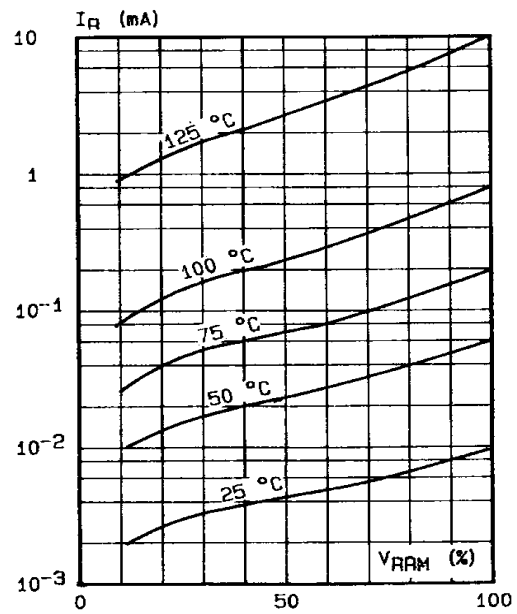

Figure 5. Capacitance C versus reverse applied voltage V_R (typical values).

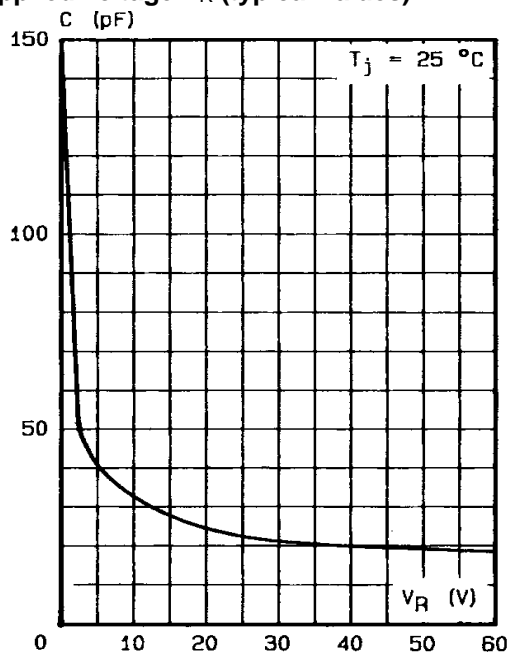

Figure 6. Surge non repetitive forward current for a rectangular pulse with $t \leq 10$ ms.

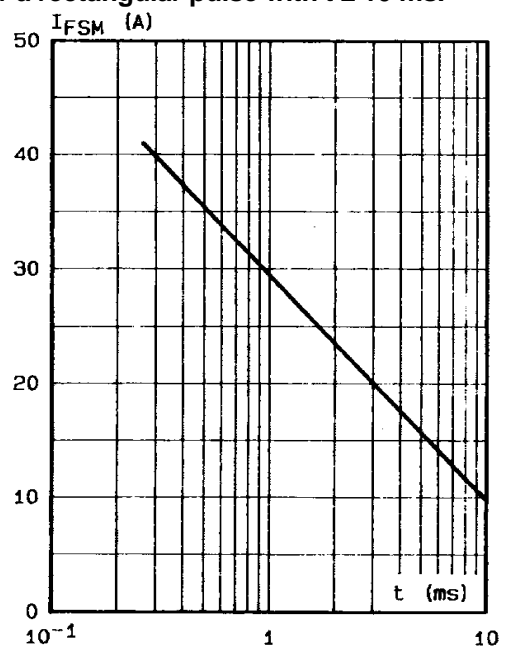
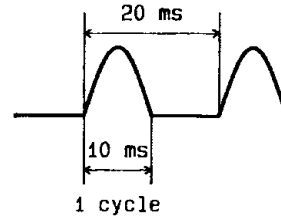
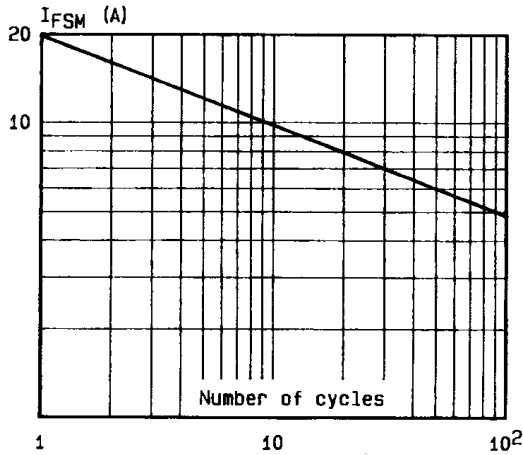
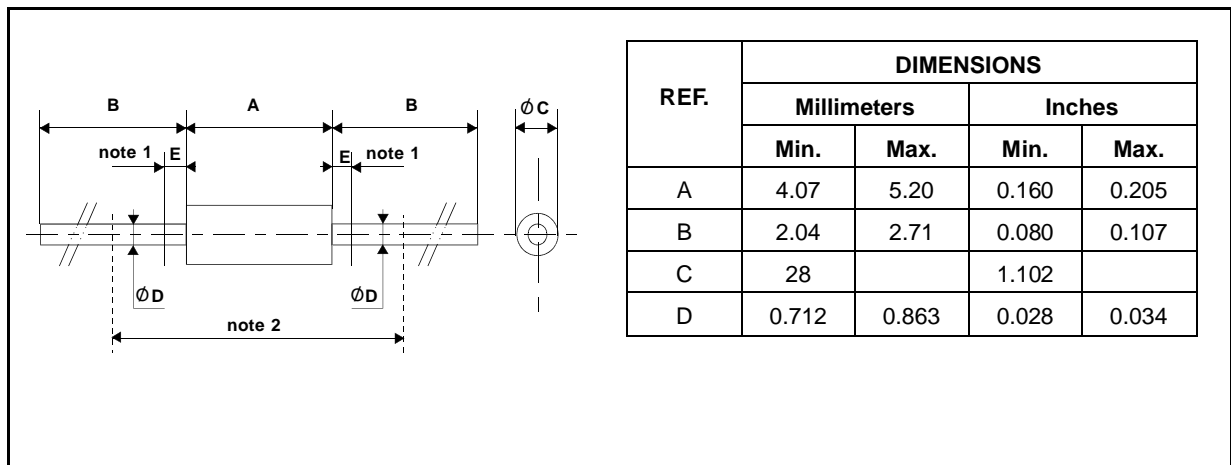

Figure 7. Surge non repetitive forward current versus number of cycles.



PACKAGE MECHANICAL DATA

DO 41 Glass



Cooling method : by convection and conduction
 Marking: clear, ring at cathode end.
 Weight: 0.34g

Information furnished is believed to be accurate and reliable. However, STMicroelectronics assumes no responsibility for the consequences of use of such information nor for any infringement of patents or other rights of third parties which may result from its use. No license is granted by implication or otherwise under any patent or patent rights of STMicroelectronics. Specifications mentioned in this publication are subject to change without notice. This publication supersedes and replaces all information previously supplied. STMicroelectronics products are not authorized for use as critical components in life support devices or systems without express written approval of STMicroelectronics.

The ST logo is a registered trademark of STMicroelectronics
 © 1999 STMicroelectronics - Printed in Italy - All rights reserved.

STMicroelectronics GROUP OF COMPANIES
 Australia - Brazil - China - Finland - France - Germany - Hong Kong - India - Italy - Japan - Malaysia
 Malta - Morocco - Singapore - Spain - Sweden - Switzerland - United Kingdom - U.S.A.

<http://www.st.com>



This datasheet has been download from:

www.datasheetcatalog.com

Datasheets for electronics components.