

## Description

Standard gate triggering SCR is fully isolated package suitable for the application where requiring high bidirectional blocking voltage capability and also suitable for over voltage protection, motor control circuit in power tool, inrush current limit circuit and heating control system.

## Simplified outline

### TO-126

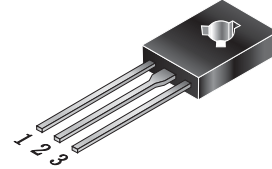

## Features

- Blocking voltage to 600 V
- On-state RMS current to 4 A

## Symbol

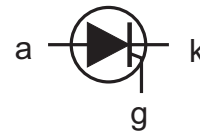

## Applications

- Motor control
- Industrial and domestic lighting
- Heating
- Static switching

Pin	Description
1	cathode
2	anode
3	gate
TAB	anode

SYMBOL	PARAMETER		Value	Unit
$V_{DRM}$	Repetitive peak off-state voltages	C106DG C106MG	400 600	V
$I_T (RMS)$	RMS on-state current (full sine wave)		4	A
$I_{TSM}$	Non-repetitive peak on-state current		20	A

SYMBOL	PARAMETER	CONDITIONS	MIN	TYP	MAX	UNIT
$R_{\theta JC}$	Thermal resistance Junction to case		-	-	3	°C/W
$R_{\theta JA}$	Thermal resistance Junction to ambient		-	-	75	°C/W

**Limiting values in accordance with the Maximum system(IEC 134)**

SYMBOL	PARAMETER	CONDITIONS	MIN	Value	UNIT
$V_{DRM}$ $V_{RRM}$	Repetitive peak off-state Voltages	RGK=1K $\Omega$ TC=-40° to 110°C C106DG C106MG	-	400 600	V
$I_{T(RMS)}$	RMS on-state current	all conduction angles	-	4	A
$I_{TSM}$	Non-repetitive peak On-state current	1/2Cycle,60Hz,Tj=-40 to +110°C	-	20	A
$I^2t$	Circuit Fusing	T=8.3ms	-	1.65	A <sup>2</sup> S
$I_{T(AV)}$	Average Forward Current	(180° Conduction Angles, Tc = 80°C)	-	2.55	A
$I_{GM}$	Forward Peak gate current	(Pulse Width 1.0 sec, Tc = 80°C)	-	0.2	A
$V_{GRM}$	Peak gate voltage	(IGR = 10 A)	-	6	V
$P_{GM}$	Forward Peak Gate Power	(Pulse Width 1.0 sec, Tc = 80°C)	-	0.5	W
$P_{G(AV)}$	Forward Average Gate Power	(Pulse Width 1.0 sec, Tc = 80°C)	-	0.1	W
$T_{stg}$	Storage temperature		-40	150	°C
$T_j$	Operating junction Temperature		-40	110	°C

**T<sub>j</sub> =25 °C unless otherwise stated**

SYMBOL	PARAMETER	CONDITIONS	MIN	TYP	MAX	UNIT
Static characteristics						
$I_{GT}$	Gate trigger current	$V_{AK}=6V_{dc}, R_L=100\text{ Ohms}, T_j=25^\circ\text{C}$ $V_{AK}=6V_{dc}, R_L=100\text{ Ohms}, T_j=-40^\circ\text{C}$	-	30 75	200 500	$\mu\text{A}$
$I_H$	Holding current	$V_D=12V_{dc}; R_{GK}=1000\text{ Ohms}$ Tj=25°C Tj=-40°C Tj=+110°C	-	0.3 0.4 0.14	3 6 2	mA
$I_L$	Latching Current	$V_{AK}=12V; I_G=20\text{ mA}$ Tj=25°C Tj=-40°C	-	0.2 0.35	5 7	mA
$V_{TM}$	Peak Forward On-State Voltage	(ITM = 4 A)	-	-	2.2	V
$V_{GT}$	Gate trigger voltage	(VAK = 6 Vdc, RL = 100Ohms) Tj=25°C	0.4	0.6	0.8	V
			Tj=-40°C	0.5	0.75	1.0
$V_{GD}$	Gate Non-Trigger Voltage	$V_{AK}=12V, R_L=100\text{ Ohms}; T_j=110^\circ\text{C}$	0.2	-	-	V

**Dynamic Characteristics**

$D_v/dt$	Critical Rate-of-Rise of Off-State Voltage	Tj=110°C, R <sub>GK</sub> =1000 Ohms, V <sub>AK</sub> =Rated V <sub>DRM</sub>	-	8	-	V/ $\mu\text{s}$
----------	--	--	---	---	---	------------------

## Description

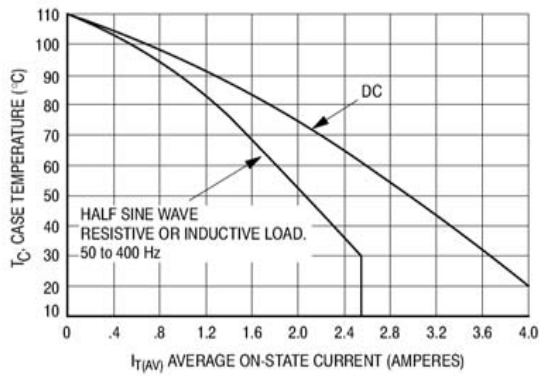

Figure 1. Average Current Derating

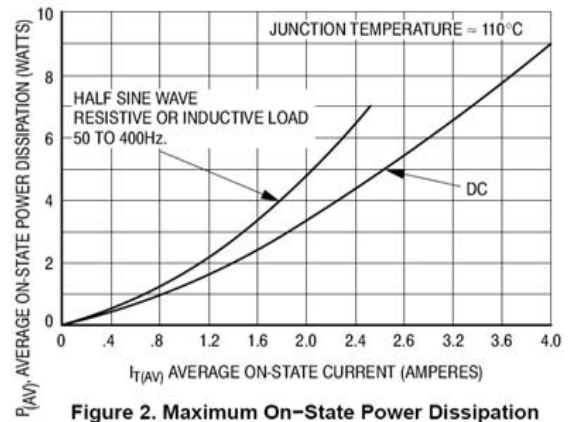

Figure 2. Maximum On-State Power Dissipation

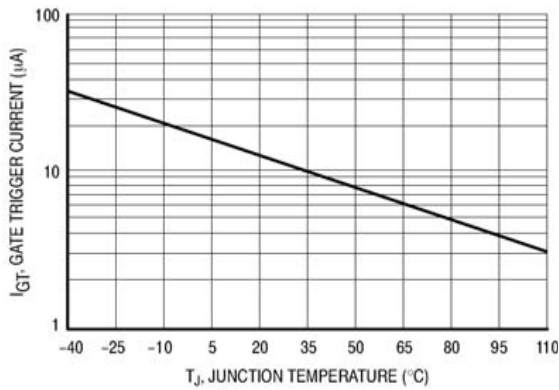

Figure 3. Typical Gate Trigger Current versus Junction Temperature

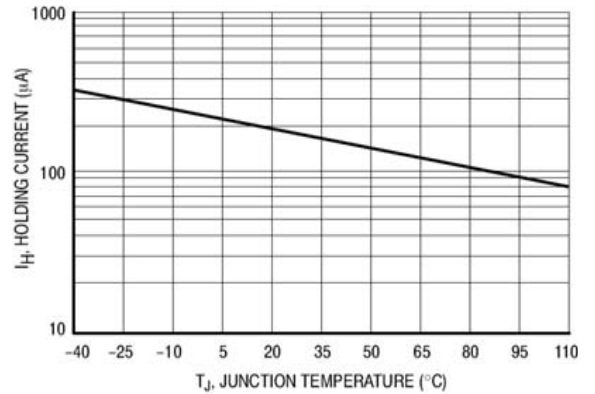

Figure 4. Typical Holding Current versus Junction Temperature

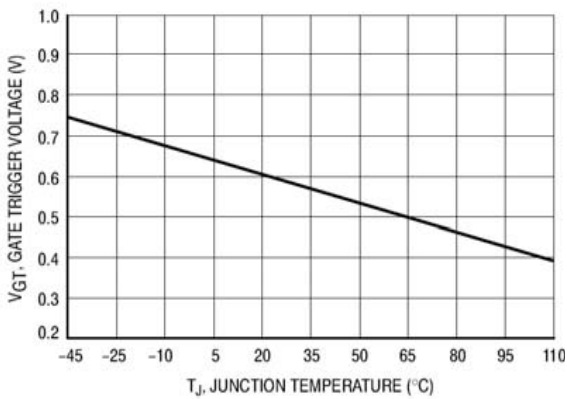

Figure 5. Typical Gate Trigger Voltage versus Junction Temperature

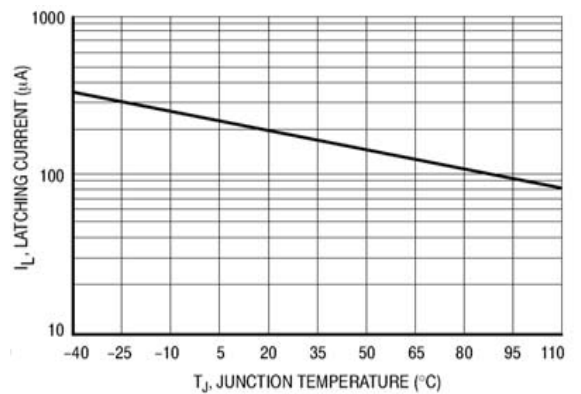
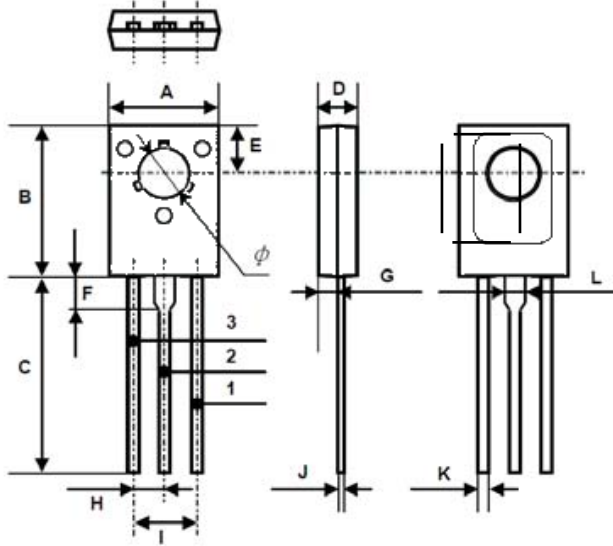

Figure 6. Typical Latching Current versus Junction Temperature

## Mechanical Data

### TO-126

Dimensions in mm  
Net Mass: 0.8 g



Package Dimension

Dim.	mm			Inch		
	Min.	Typ.	Max.	Min.	Typ.	Max.
A	7.5		7.9	0.295		0.311
B	10.8		11.2	0.425		0.441
C	14.2		14.7	0.559		0.579
D	2.7		2.9	0.106		0.114
E		3.8			0.150	
F		2.5			0.098	
G	1.2		1.5	0.047		0.059
H		2.3			0.091	
I		4.6			0.181	
J	0.48		0.62	0.019		0.024
K	0.7		0.86	0.028		0.034
L		1.4			0.055	
phi		3.2			0.126	