

FRED

Ultrafast Soft Recovery Diode, 2 x 10 A

FEATURES

- Ultrafast recovery
- Ultrasoft recovery
- Very low I_{RRM}
- Very low Q_{rr}
- Specified at operating conditions
- Designed and qualified for industrial level

BENEFITS

- Reduced RFI and EMI
- Reduced power loss in diode and switching transistor.
- Higher frequency operation
- Reduced snubbing
- Reduced parts count

APPLICATIONS

- Switching mode power supplies
- UPS
- DC/DC converters
- Free wheeling diodes
- Inverters
- Motor drives

DESCRIPTION

D92-02 is a state of the art center tap ultrafast recovery diode. Employing the latest in epitaxial construction and advanced processing techniques it features a superb combination of characteristics which result in performance which is unsurpassed by any rectifier previously available. With basic ratings of 200V and 10 A per leg continuous current, the **D92-02** is especially well suited for use as the companion diode for IGBTs and MOSFETs. The FRED features combine to offer designers a rectifier with lower noise and significantly lower switching losses in both the diode and the switching transistor. These FRED advantages can help to significantly reduce snubbing, component count and heatsink sizes.

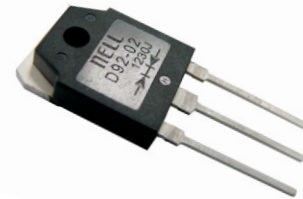

TO-3PB

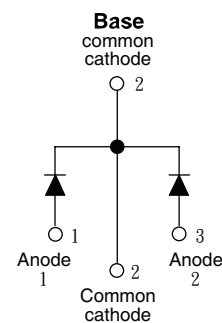

PRODUCT SUMMARY	
V_R	200 V
V_F at 10A at 25 °C	0.95 V
$I_{F(AV)}$	2 x 10 A
t_{rr} (typical)	35 ns
T_J (maximum)	150 °C
Q_{rr} (typical)	25 nC
I_{RRM} (typical)	1.9 A

ABSOLUTE MAXIMUM RATINGS				
PARAMETER	SYMBOL	TEST CONDITIONS	VALUES	UNIT
Cathode to anode voltage	V_R		200	V
Maximum continuous forward current	I_F	per leg	10	A
		per device	20	
Single pulse forward current (Peak forward current per leg)	I_{FSM}	50Hz square wave duty = 1/2, $T_C = 115^\circ\text{C}$	100	
Maximum repetitive forward current (per leg)	I_{FRM}		40	
Operating junction and storage temperature range	T_J, T_{Stg}		- 55 to + 150	°C

Nell High Power Products

ELECTRICAL SPECIFICATIONS ($T_J = 25\text{ }^\circ\text{C}$ unless otherwise specified)						
PARAMETER	SYMBOL	TEST CONDITIONS	MIN.	TYP.	MAX.	UNIT
Cathode to anode breakdown voltage	V_{BR}	$I_R = 100\ \mu\text{A}$	200	-	-	V
Maximum forward voltage	V_{FM}	$I_F = 10\ \text{A}$	-	0.9	0.95	
		$I_F = 20\ \text{A}$	-	1	-	
		$I_F = 10\ \text{A}, T_J = 125\text{ }^\circ\text{C}$	-	0.8	-	
Maximum reverse leakage current	I_{RM}	$V_R = V_R\ \text{rated}$	-	-	15	μA
		$T_J = 125\text{ }^\circ\text{C}, V_R = V_R\ \text{rated}$	-	-	250	
Junction capacitance	C_T	$V_R = 200\text{V}$	-	55	-	pF
Series inductance	L_S	Measured lead to lead 5 mm from package body	-	8	-	nH

DYNAMIC RECOVERY CHARACTERISTICS PER LEG $T_J = 25\text{ }^\circ\text{C}$ unless otherwise specified)						
PARAMETER	SYMBOL	TEST CONDITIONS	MIN.	TYP.	MAX.	UNIT
Reverse recovery time	t_{rr}	$I_F = 0.5\text{A}, I_R = 1.0\text{A}, I_{RR} = 250\text{mA}$ (RG#1 CKT)	-	14	20	ns
		$I_F = 1.0\ \text{A}, di_F/dt = 50\ \text{A}/\mu\text{s}, V_R = 30\ \text{V}, T_J = 25\text{ }^\circ\text{C}$	-	-	30	
	t_{rr1}	$T_J = 25\text{ }^\circ\text{C}$	-	21	-	
	t_{rr2}	$T_J = 125\text{ }^\circ\text{C}$	-	35	-	
Peak recovery current	I_{RRM1}	$T_J = 25\text{ }^\circ\text{C}$	-	1.9	-	A
	I_{RRM2}	$T_J = 125\text{ }^\circ\text{C}$	-	4.8	-	
Reverse recovery charge	Q_{rr1}	$T_J = 25\text{ }^\circ\text{C}$	-	25	-	nC
	Q_{rr2}	$T_J = 125\text{ }^\circ\text{C}$	-	78	-	

THERMAL - MECHANICAL SPECIFICATIONS PER LEG						
PARAMETER	SYMBOL	TEST CONDITIONS	MIN.	TYP.	MAX.	UNITS
Lead temperature	T_{lead}	0.063" from case (1.6 mm) for 10 s	-	-	300	$^\circ\text{C}$
Junction to case, single leg conduction	R_{thJC}		-	-	1.5	K/W
Junction to case, both legs conducting			-	-	0.7	
Thermal resistance, junction to ambient	R_{thJA}	Typical socket mount	-	-	40	
Thermal resistance, case to heatsink	R_{thCS}	Mounting surface, flat, smooth and greased	-	0.25	-	
Weight			-	5.5 0.19	-	g oz.
Mounting torque			6 (5)	-	12 (10)	kgf . cm (lb . in)
Marking device		Case style TO-3PB (JEDEC)	D92-02			

ORDERING INFORMATION TABLE

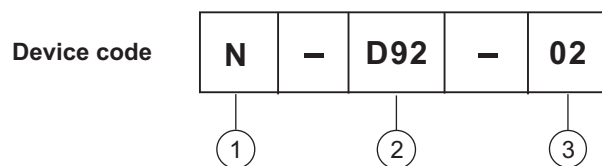

- ① - Nell Semiconductors product
- ② - FRED family, type = D92, current rating = 10A x 2, package outline = TO-3PB
- ③ - Voltage rating, 02 = 200V

Nell High Power Products

Fig.1 Maximum forward voltage drop characteristics

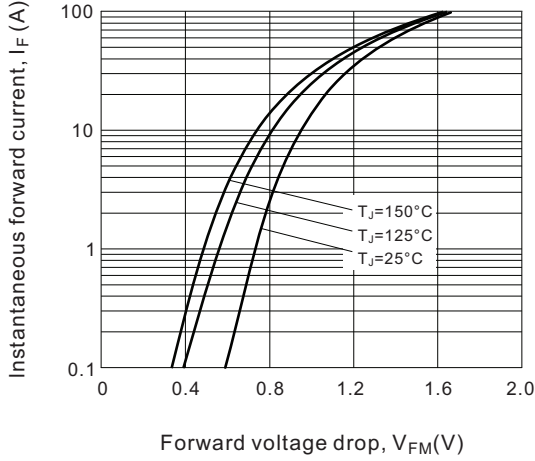

Fig.2 Typical values of reverse current vs. reverse voltage

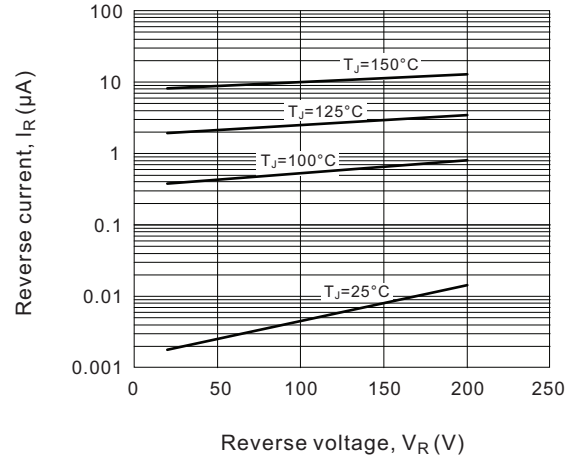

Fig.3 Typical junction capacitance vs. reverse voltage

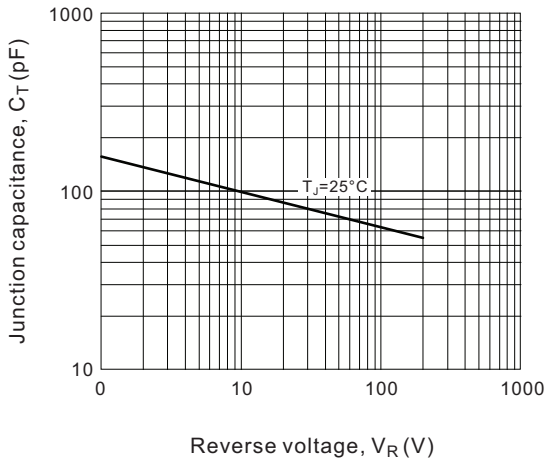

Fig.4 Maximum allowable case temperature vs. average forward current

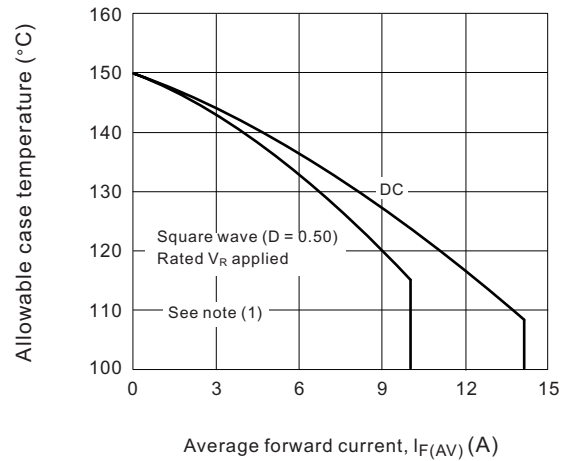

Fig.5 Maximum thermal impedance $R_{th(j-c)}$ characteristics

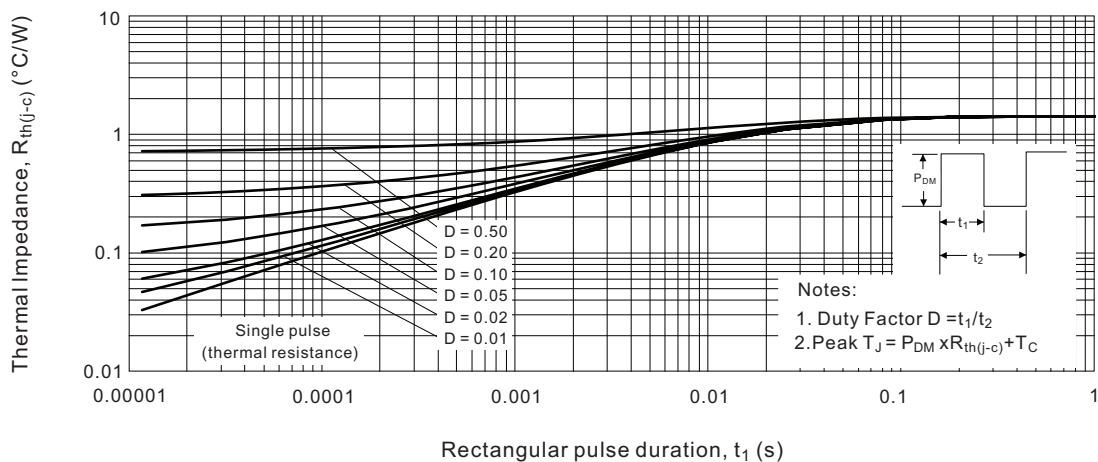

Fig.6 Forward power loss characteristics

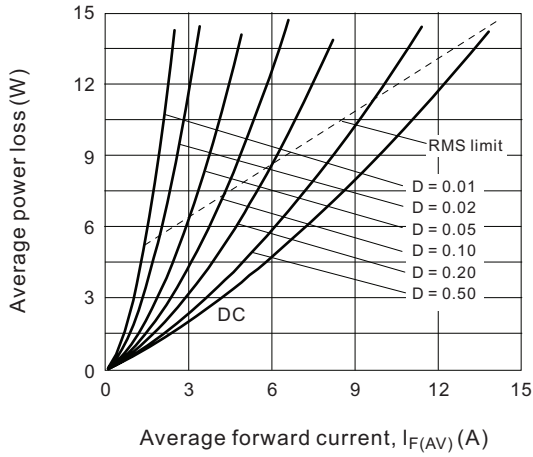

Fig.7 Typical reverse recovery time vs. di_F/dt

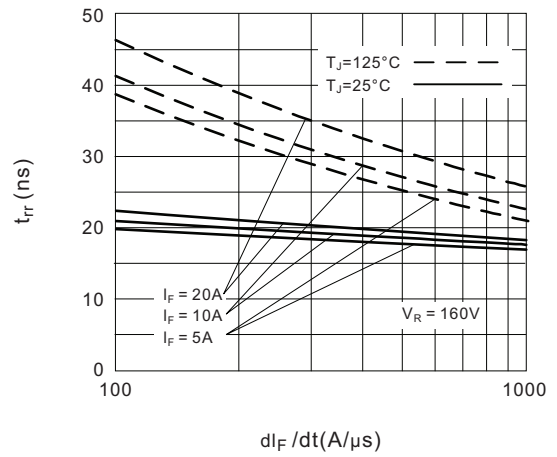

Fig.8 Typical stored charge vs. di_F/dt

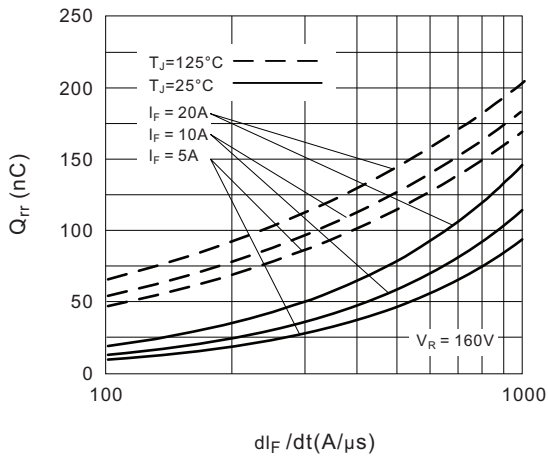
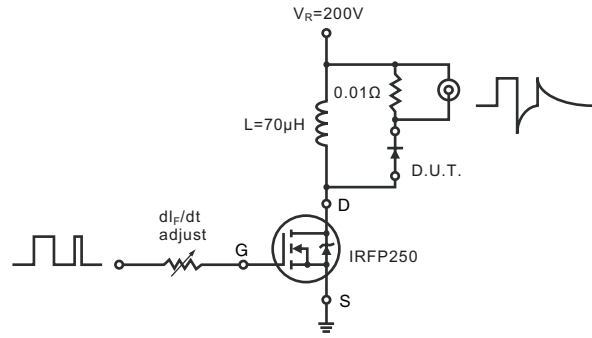

Fig.9 Reverse recovery parameter test circuit



Note

- (1) Formula used: $T_C = T_J - (P_d + P_{dREV}) \times R_{thJC}$;
- P_d = Forward power loss = $I_{F(AV)} \times V_{FM}$ at $(I_{F(AV)}/D)$ (see fig.6);
- P_{dREV} = Inverse power loss = $V_{R1} \times I_R (1-D)$; I_R at V_{R1} = Rated V_R

Fig.10 Reverse recovery waveform and definitions

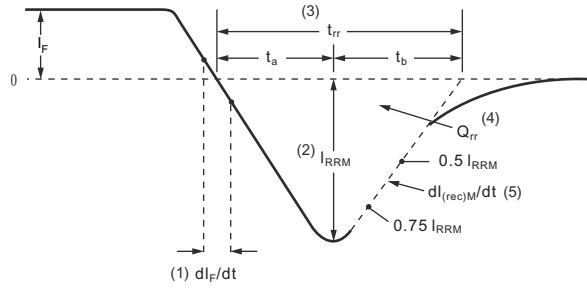

- (1) di_F/dt - rate of change of current through zero crossing
- (2) I_{RRM} - peak reverse recovery current
- (3) t_{rr} - reverse recovery time measured from zero crossing point of negative going I_F to point where a line passing through $0.75 I_{RRM}$ and $0.50 I_{RRM}$ extrapolated to zero current.
- (4) Q_{rr} - area under curve defined by t_{rr} and I_{RRM}
- (5) $dl_{(rec)M}/dt$ - peak rate of change of current during t_b portion of t_{rr}

$$Q_{rr} = \frac{t_{rr} \times I_{RRM}}{2}$$

TO-3PB

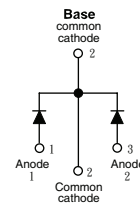
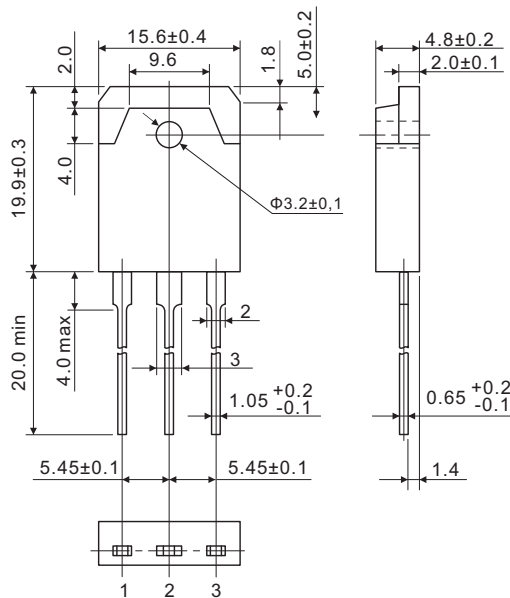

All dimensions in millimeters