

MOSFET – N-Channel, UniFET™

500 V, 18 A, 265 mΩ

FDP18N50 / FDPF18N50 / FDPF18N50T

Description

UniFET MOSFET is onsemi's high voltage MOSFET family based on planar stripe and DMOS technology. This MOSFET is tailored to reduce on-state resistance, and to provide better switching performance and higher avalanche energy strength. This device family is suitable for switching power converter applications such as power factor correction (PFC), flat panel display (FPD) TV power, ATX and electronic lamp ballasts.

Features

- $R_{DS(on)} = 220 \text{ m}\Omega$ (Typ.) @ $V_{GS} = 10 \text{ V}$, $I_D = 9 \text{ A}$
- Low Gate Charge (Typ. 45 nC)
- Low C_{rss} (Typ. 25 pF)
- 100% Avalanche Tested
- These Devices are Pb-Free and are RoHS Compliant

Applications

- LCD/LED/PDP TV
- Lighting
- Uninterruptible Power Supply

V_{DS}	$R_{DS(on)}$ MAX	I_D MAX
500 V	265 mΩ @ 9 V	18 A

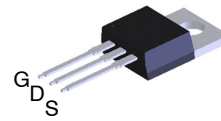
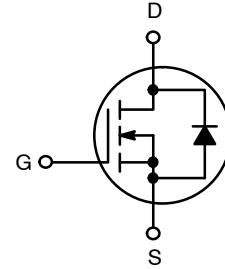

TO-220-3LD
CASE 340AT

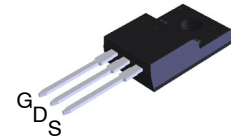

TO-220 Fullpack, 3-Lead
/ TO-220F-3SG
CASE 221AT

MARKING DIAGRAM

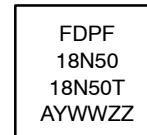
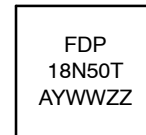

FDP18N50,
FDPF18N50
FDPF18N50T = Specific Device Code
A = Assembly Location
YWW = Date Code (Year and Week)
ZZ = Assembly Lot Code

ORDERING INFORMATION

Device	Package	Shipping
FDP18N50	TO-220	1000 Units / Tube
FDPF18N50	TO-220F	1000 Units / Tube
FDPF18N50T	TO-220F	1000 Units / Tube

FDP18N50 / FDPF18N50 / FDPF18N50T

MOSFET MAXIMUM RATINGS ($T_C = 25^\circ\text{C}$ unless otherwise noted)

Symbol	Parameter	FDP18N50	FDPF18N50 / FDPF18N50T	Unit
V_{DSS}	Drain to Source Voltage	500		V
I_D	Drain Current – – Continuous ($T_C = 25^\circ\text{C}$) – Continuous ($T_C = 100^\circ\text{C}$)	18 10.8	18* 10.8*	A
I_{DM}	Drain Current – Pulsed (Note 1)	72	72*	A
V_{GSS}	Gate to Source Voltage	± 30		V
E_{AS}	Single Pulsed Avalanche Energy (Note 2)	945		mJ
I_{AR}	Avalanche Current (Note 1)	18		A
E_{AR}	Repetitive Avalanche Energy (Note 1)	23.5		mJ
dv/dt	Peak Diode Recovery dv/dt (Note 3)	4.5		V/ns
P_D	Power Dissipation ($T_C = 25^\circ\text{C}$) – Derate Above 25°C	235 1.88	38.5 0.3	W W/ $^\circ\text{C}$
T_J, T_{STG}	Operating and Storage Temperature Range	–55 to +150		$^\circ\text{C}$
T_L	Maximum Lead Temperature for Soldering, 1/8" from Case for 5 Second	300		$^\circ\text{C}$

Stresses exceeding those listed in the Maximum Ratings table may damage the device. If any of these limits are exceeded, device functionality should not be assumed, damage may occur and reliability may be affected.

*Drain current limited by maximum junction temperature

1. Repetitive Rating: Pulse width limited by maximum junction temperature.
2. $L = 5.2\text{ mH}$, $I_{AS} = 18\text{ A}$, $V_{DD} = 50\text{ V}$, $R_G = 25\ \Omega$, Starting $T_J = 25^\circ\text{C}$
3. $I_{SD} \leq 18\text{ A}$, $di/dt \leq 200\text{ A}/\mu\text{s}$, $V_{DD} \leq BV_{DSS}$, Starting $T_J = 25^\circ\text{C}$

THERMAL CHARACTERISTICS

Symbol	Parameter	FDP18N50	FDPF18N50 / FDPF18N50T	Unit
$R_{\theta JC}$	Thermal Resistance, Junction-to-Case, Max.	0.53	3.3	$^\circ\text{C}/\text{W}$
$R_{\theta JA}$	Thermal Resistance, Junction-to-Ambient, Max.	62.5	62.5	$^\circ\text{C}/\text{W}$

ELECTRICAL CHARACTERISTICS ($T_J = 25^\circ\text{C}$ unless otherwise noted)

Parameter	Symbol	Test Condition	Min	Typ	Max	Unit
-----------	--------	----------------	-----	-----	-----	------

OFF CHARACTERISTICS

BV_{DSS}	Drain-Source Breakdown Voltage	$V_{GS} = 0, I_D = 250\ \mu\text{A}$,	500	–	–	V
$\Delta BV_{DSS} / \Delta T_J$	Breakdown Voltage Temperature Coefficient	$I_D = 250\ \mu\text{A}$, Referenced to 25°C	–	0.5	–	V/ $^\circ\text{C}$
I_{DSS}	Zero Gate Voltage Drain Current	$V_{DS} = 500\text{ V}, V_{GS} = 0\text{ V}$	–	–	1	μA
		$V_{DS} = 400\text{ V}, T_C = 125^\circ\text{C}$	–	–	10	
I_{GSSF}	Gate-Body Leakage Current, Forward	$V_{GS} = 30\text{ V}, V_{DS} = 0\text{ V}$	–	–	100	nA
I_{GSSR}	Gate-Body Leakage Current, Reverse	$V_{GS} = -30\text{ V}, V_{DS} = 0\text{ V}$	–	–	-100	nA

ON CHARACTERISTICS

$V_{GS(th)}$	Gate Threshold Voltage	$V_{GS} = V_{DS}, I_D = 250\ \mu\text{A}$	3.0	–	5.0	V
$R_{DS(on)}$	Static Drain-Source On-Resistance	$V_{GS} = 10\text{ V}, I_D = 9\text{ A}$	–	0.220	0.265	Ω
g_{FS}	Forward Transconductance	$V_{DS} = 40\text{ V}, I_D = 9\text{ A}$	–	25	–	S

DYNAMIC CHARACTERISTICS

C_{iss}	Input Capacitance	$V_{DS} = 25\text{ V}, V_{GS} = 0\text{ V}, f = 1\text{ MHz}$	–	2200	2860	pF
C_{oss}	Output Capacitance		–	330	430	pF
C_{rss}	Reverse Transfer Capacitance		–	25	40	pF

FDP18N50 / FDPF18N50 / FDPF18N50T

ELECTRICAL CHARACTERISTICS (T_J = 25°C unless otherwise noted) (continued)

Parameter	Symbol	Test Condition	Min	Typ	Max	Unit
-----------	--------	----------------	-----	-----	-----	------

SWITCHING CHARACTERISTICS

t _{d(on)}	Turn-On Delay Time	V _{DD} = 250 V, I _D = 18 A, V _{GS} = 10 V, R _G = 25 Ω (Note 4)	–	55	120	ns
t _r	Turn-On Rise Time		–	165	340	ns
t _{d(off)}	Turn-Off Delay Time		–	95	200	ns
t _f	Turn-Off Fall Time		–	90	190	ns
Q _g	Total Gate Charge	V _{DS} = 400 V, I _D = 18 A, V _{GS} = 10 V (Note 4)	–	45	60	nC
Q _{gs}	Gate-Source Charge		–	12.5	–	nC
Q _{gd}	Gate-Drain Charge		–	19	–	nC

DRAIN-SOURCE DIODE CHARACTERISTICS AND MAXIMUM RATINGS

I _S	Maximum Continuous Drain-Source Diode Forward Current		–	–	18	A
I _{SM}	Maximum Pulsed Drain- Source Diode Forward Current		–	–	72	A
V _{SD}	Drain-Source Diode Forward Voltage	V _{GS} = 0 V, I _{SD} = 18 A	–	–	1.4	V
t _{rr}	Reverse Recovery Time	V _{GS} = 0 V, I _{SD} = 18 A dI _F /dt = 100 A/μs	–	500	–	ns
Q _{rr}	Reverse Recovery Charge		–	5.4	–	μC

Product parametric performance is indicated in the Electrical Characteristics for the listed test conditions, unless otherwise noted. Product performance may not be indicated by the Electrical Characteristics if operated under different conditions.

4. Essentially Independent of Operating Temperature Typical Characteristics

TYPICAL PERFORMANCE CHARACTERISTICS

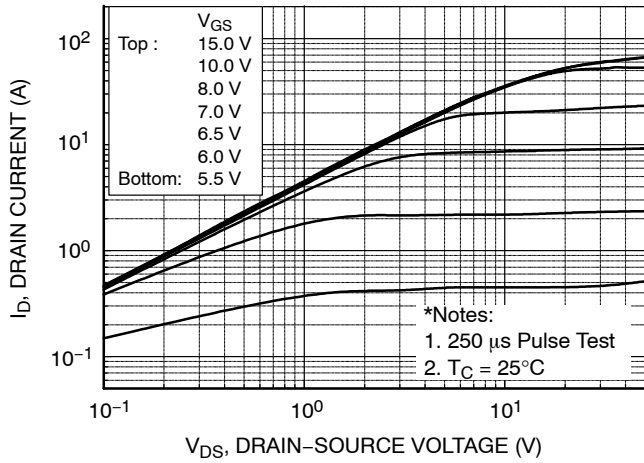

Figure 1. On-Resistance Characteristics

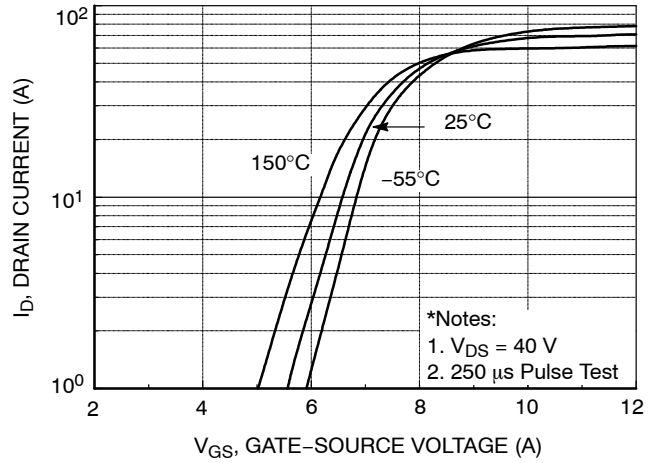

Figure 2. Transfer Characteristics

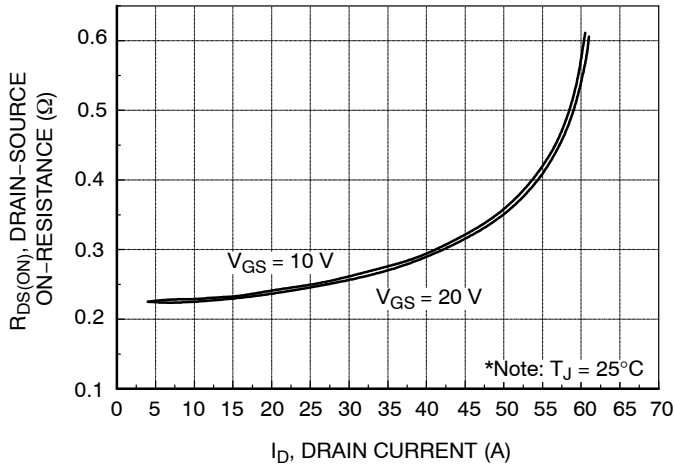

Figure 3. On-Resistance Variation vs. Drain Current and Gate Voltage

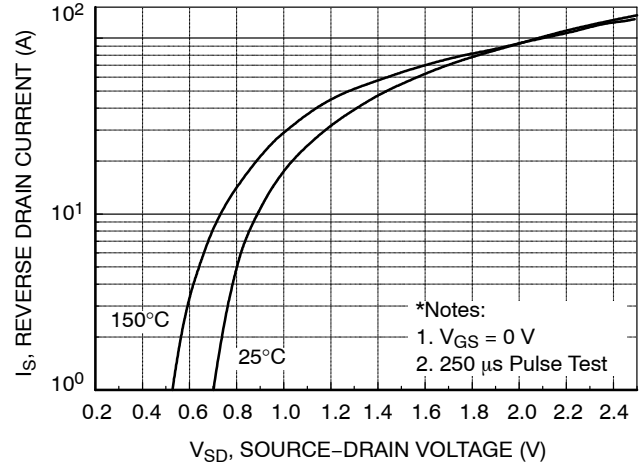

Figure 4. Body Diode Forward Voltage Variation vs. Source Current and Temperature

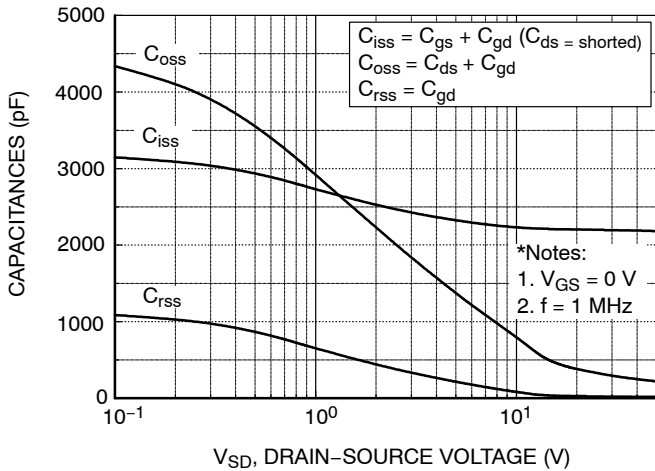

Figure 5. Capacitance Characteristics

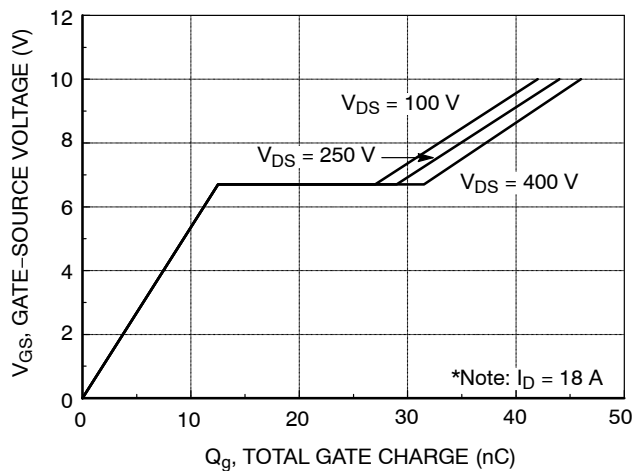

Figure 6. Gate Charge Characteristics

FDP18N50 / FDPF18N50 / FDPF18N50T

TYPICAL CHARACTERISTICS (CONTINUED)

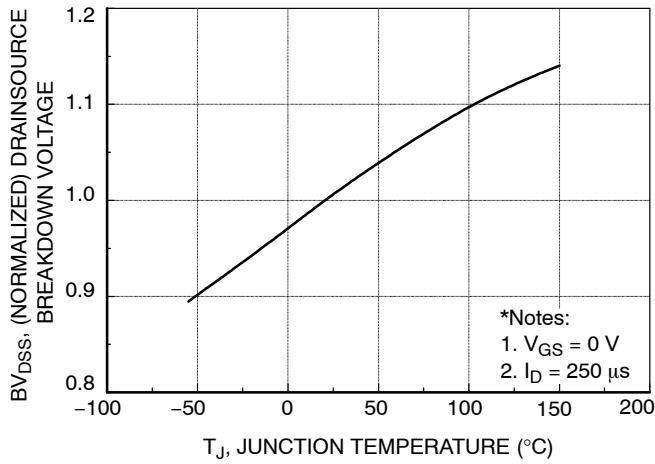

Figure 7. Breakdown Voltage Variation vs. Temperature

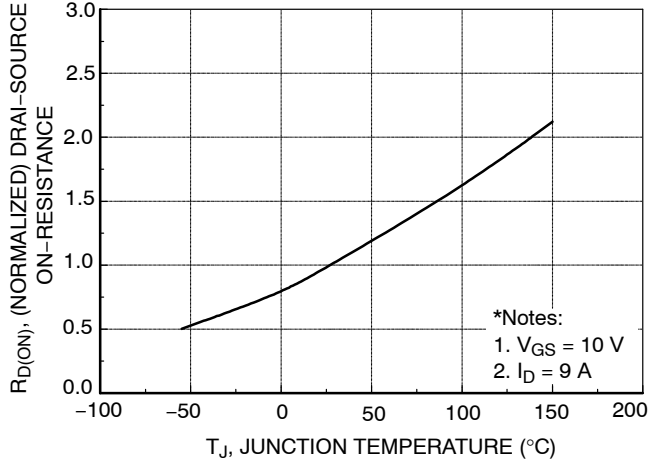

Figure 8. On-Resistance Variation vs. Temperature

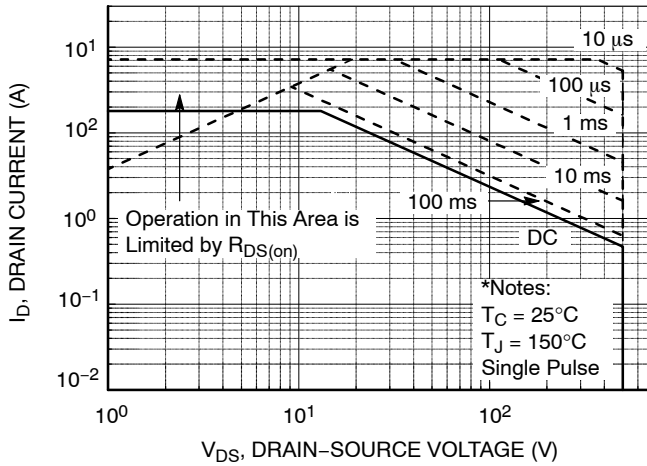

Figure 9-1. Maximum Safe Operating Area for FDP18N50

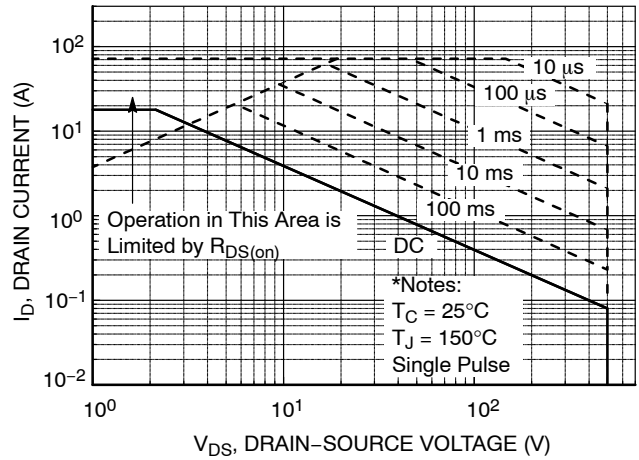

Figure 9-2. Maximum Safe Operating Area for FDPF18N50 / FDPF18N50T

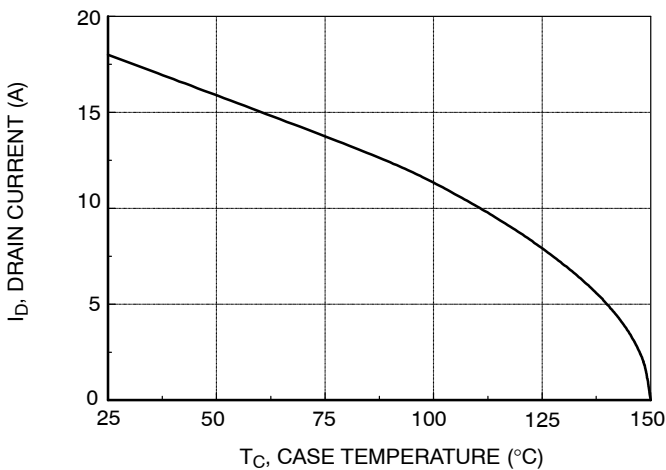

Figure 10. Maximum Drain Current vs. Case Temperature

FDP18N50 / FDPF18N50 / FDPF18N50T

TYPICAL PERFORMANCE CHARACTERISTICS (CONTINUED)

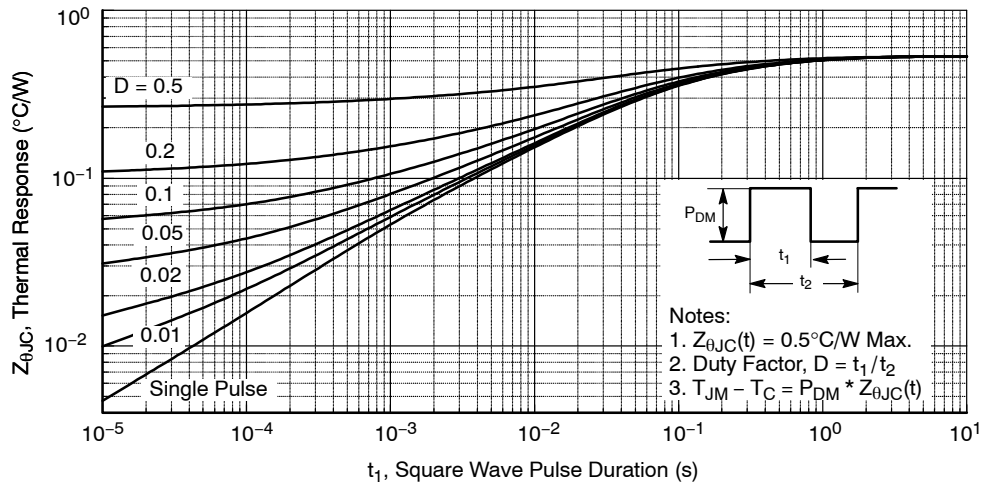

Figure 11 -1. Transient Thermal Response Curve - FDP18N50

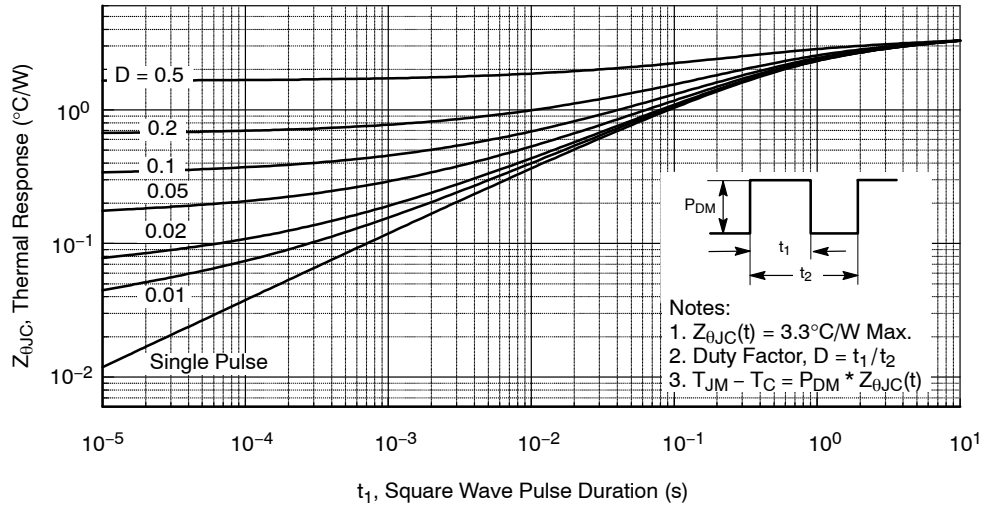

Figure 11 -2. Transient Thermal Response Curve - FDPF18N50 / FDPF18N50T

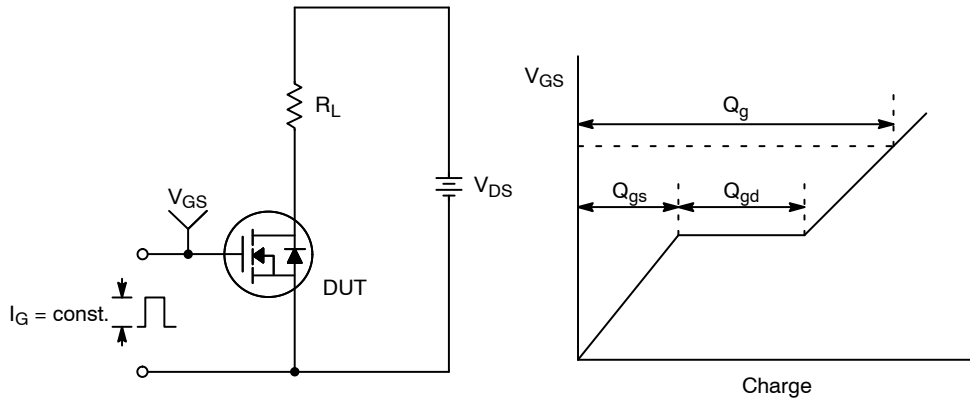

Figure 12. Gate Charge Test Circuit & Waveform

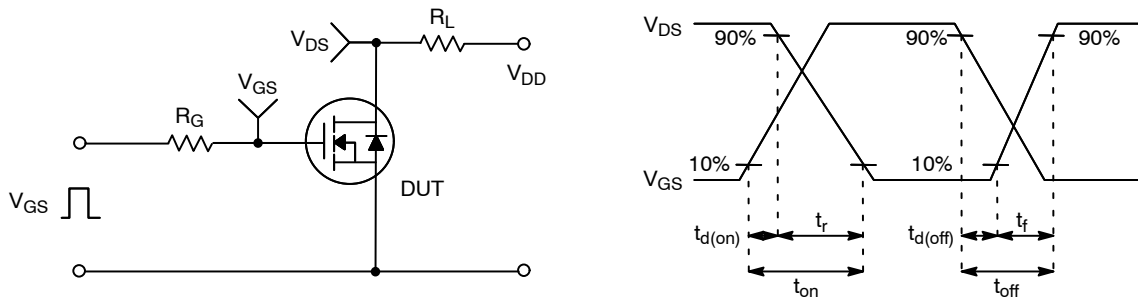

Figure 13. Resistive Switching Test Circuit & Waveforms

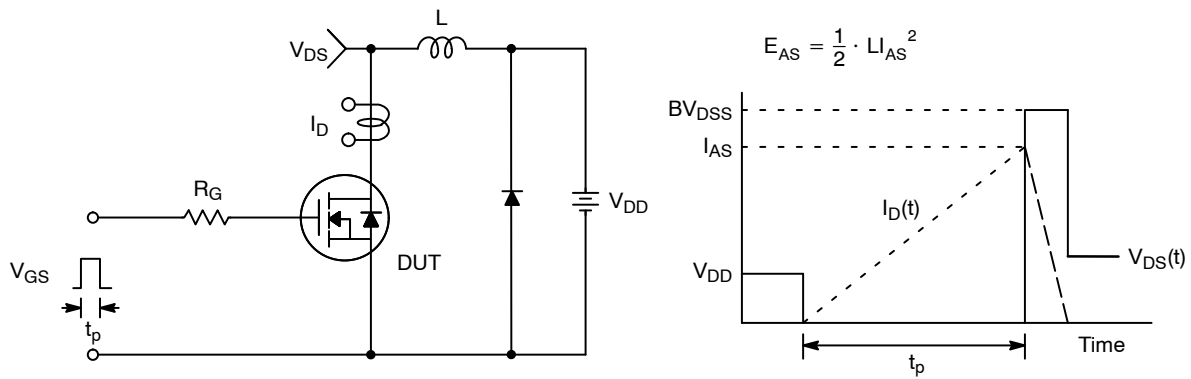

Figure 14. Unclamped Inductive Switching Test Circuit & Waveforms

FDP18N50 / FDPF18N50 / FDPF18N50T

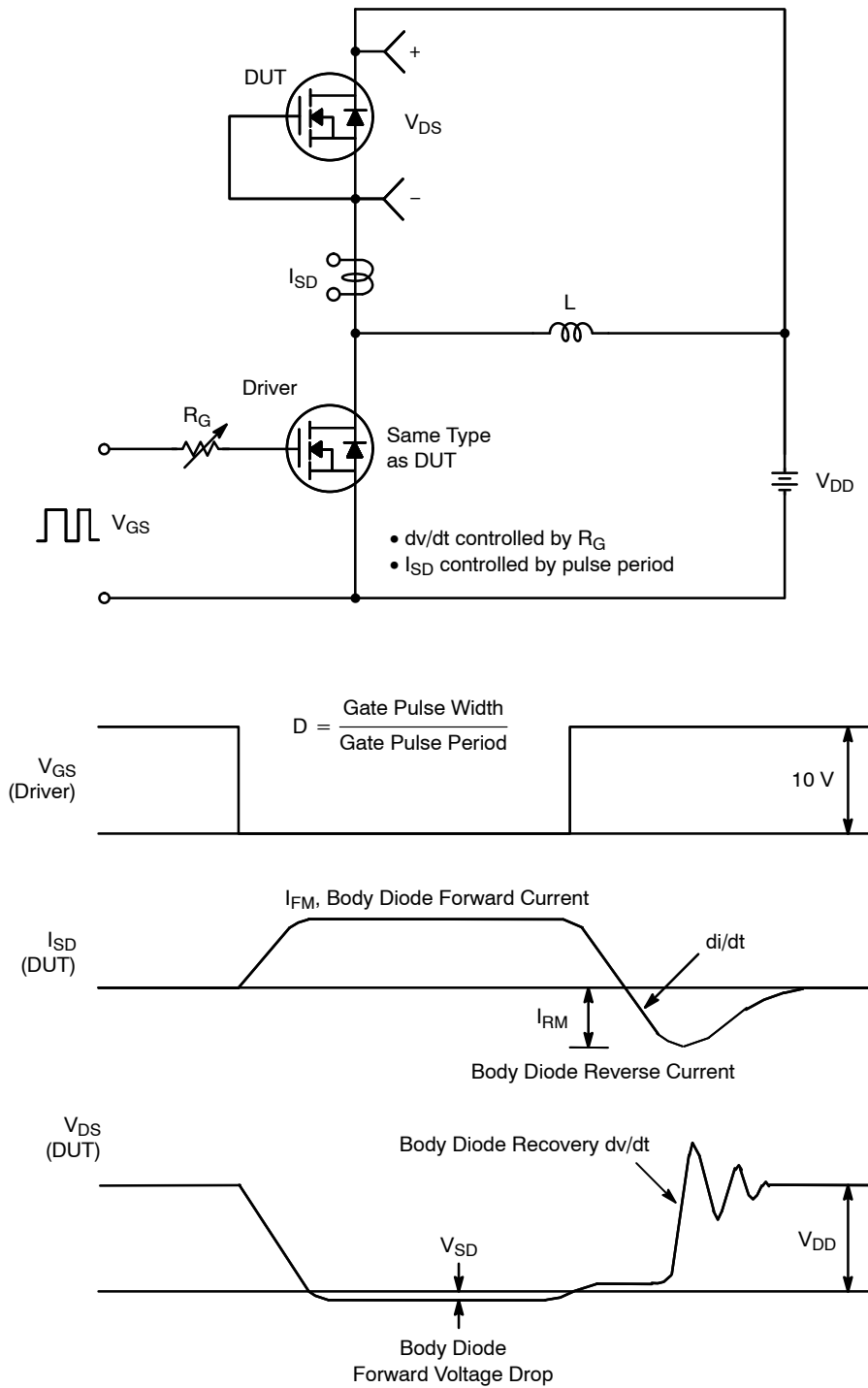
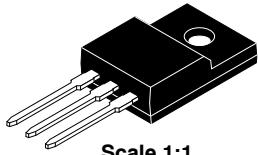

Figure 15. Peak Diode Recovery dv/dt Test Circuit & Waveforms

TO-220 Fullpack, 3-Lead / TO-220F-3SG
CASE 221AT
ISSUE B

DATE 19 JAN 2021



Scale 1:1



DIM	MILLIMETERS		
	MIN	NOM	MAX
A	4.50	4.70	4.90
A1	2.56	2.76	2.96
A2	2.34	2.54	2.74
b	0.70	0.80	0.90
b2	~	~	1.47
c	0.45	0.50	0.60
D	15.67	15.87	16.07
D1	15.60	15.80	16.00
E	9.96	10.16	10.36
e	2.34	2.54	2.74
F	~	0.84	~
H1	6.48	6.68	6.88
L	12.78	12.98	13.18
L1	3.03	3.23	3.43
Ø P	2.98	3.18	3.38
Ø P1	~	1.00	~
Q	3.20	3.30	3.40

NOTES:

- A. DIMENSION AND TOLERANCE AS ASME Y14.5-2009
- B. DIMENSIONS ARE EXCLUSIVE OF BURRS, MOLD FLASH AND TIE BAR PROTRUCTIONS.
- C. OPTION 1 - WITH SUPPORT PIN HOLE
OPTION 2 - NO SUPPORT PIN HOLE

DOCUMENT NUMBER:	98AON67439E	Electronic versions are uncontrolled except when accessed directly from the Document Repository. Printed versions are uncontrolled except when stamped "CONTROLLED COPY" in red.
DESCRIPTION:	TO-220 FULLPACK, 3-LEAD / TO-220F-3SG	PAGE 1 OF 1

onsemi and ONSEMI are trademarks of Semiconductor Components Industries, LLC dba onsemi or its subsidiaries in the United States and/or other countries. onsemi reserves the right to make changes without further notice to any products herein. onsemi makes no warranty, representation or guarantee regarding the suitability of its products for any particular purpose, nor does onsemi assume any liability arising out of the application or use of any product or circuit, and specifically disclaims any and all liability, including without limitation special, consequential or incidental damages. onsemi does not convey any license under its patent rights nor the rights of others.

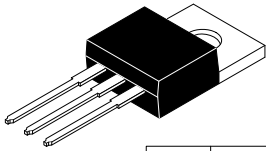

TO-220-3LD
CASE 340AT
ISSUE B

DATE 08 AUG 2022

DIM	MILLIMETERS		
	MIN.	NOM.	MAX.
A	4.00	--	4.70
A1	SEE NOTE "F"		
A2	2.10	--	2.85
b	0.55	--	1.00
b2	1.10	--	1.62
b4	1.42	--	1.62
c	0.36	--	0.60
D	13.90	--	16.30
D1	8.13	--	9.40
D2	11.50	--	14.30
D3	15.42	--	16.51
E	9.65	--	10.67
E1	7.59	--	8.65
e	2.40	--	2.67
H1	6.06	--	6.69
L	12.70	--	14.04
L1	2.70	--	4.10
P	3.50	--	4.00
Q	2.50	--	3.40
z	2.13 REF		
z1	2.06 REF		
θ	3°	--	5°

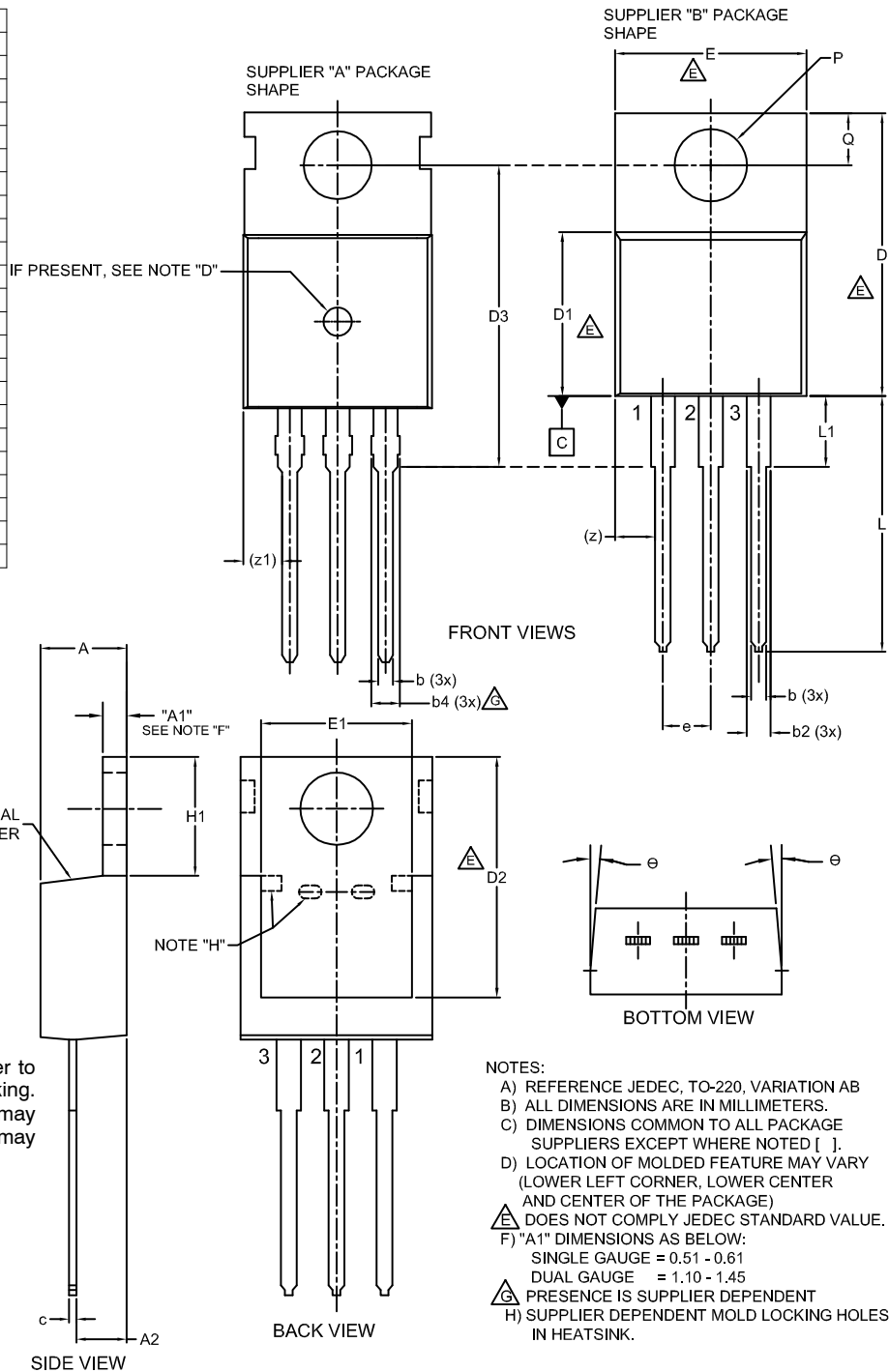

GENERIC MARKING DIAGRAM*

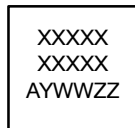

XXXX = Specific Device Code
 A = Assembly Location
 Y = Year
 WW = Work Week
 ZZ = Assembly Lot Code

*This information is generic. Please refer to device data sheet for actual part marking. Pb-Free indicator, "G" or microdot "•", may or may not be present. Some products may not follow the Generic Marking.

NOTES:

- A) REFERENCE JEDEC, TO-220, VARIATION AB
- B) ALL DIMENSIONS ARE IN MILLIMETERS.
- C) DIMENSIONS COMMON TO ALL PACKAGE SUPPLIERS EXCEPT WHERE NOTED [].
- D) LOCATION OF MOLDED FEATURE MAY VARY (LOWER LEFT CORNER, LOWER CENTER AND CENTER OF THE PACKAGE)
- ⚠ DOES NOT COMPLY JEDEC STANDARD VALUE.
- F) "A1" DIMENSIONS AS BELOW:
 SINGLE GAUGE = 0.51 - 0.61
 DUAL GAUGE = 1.10 - 1.45
- ⚠ PRESENCE IS SUPPLIER DEPENDENT
- H) SUPPLIER DEPENDENT MOLD LOCKING HOLES IN HEATSINK.

DOCUMENT NUMBER:	98AON13818G	Electronic versions are uncontrolled except when accessed directly from the Document Repository. Printed versions are uncontrolled except when stamped "CONTROLLED COPY" in red.
DESCRIPTION:	TO-220-3LD	PAGE 1 OF 1

onsemi and onsemi are trademarks of Semiconductor Components Industries, LLC dba onsemi or its subsidiaries in the United States and/or other countries. onsemi reserves the right to make changes without further notice to any products herein. onsemi makes no warranty, representation or guarantee regarding the suitability of its products for any particular purpose, nor does onsemi assume any liability arising out of the application or use of any product or circuit, and specifically disclaims any and all liability, including without limitation special, consequential or incidental damages. onsemi does not convey any license under its patent rights nor the rights of others.

onsemi, **Onsemi**, and other names, marks, and brands are registered and/or common law trademarks of Semiconductor Components Industries, LLC dba "**onsemi**" or its affiliates and/or subsidiaries in the United States and/or other countries. **onsemi** owns the rights to a number of patents, trademarks, copyrights, trade secrets, and other intellectual property. A listing of **onsemi**'s product/patent coverage may be accessed at www.onsemi.com/site/pdf/Patent-Marking.pdf. **onsemi** reserves the right to make changes at any time to any products or information herein, without notice. The information herein is provided "as-is" and **onsemi** makes no warranty, representation or guarantee regarding the accuracy of the information, product features, availability, functionality, or suitability of its products for any particular purpose, nor does **onsemi** assume any liability arising out of the application or use of any product or circuit, and specifically disclaims any and all liability, including without limitation special, consequential or incidental damages. Buyer is responsible for its products and applications using **onsemi** products, including compliance with all laws, regulations and safety requirements or standards, regardless of any support or applications information provided by **onsemi**. "Typical" parameters which may be provided in **onsemi** data sheets and/or specifications can and do vary in different applications and actual performance may vary over time. All operating parameters, including "Typicals" must be validated for each customer application by customer's technical experts. **onsemi** does not convey any license under any of its intellectual property rights nor the rights of others. **onsemi** products are not designed, intended, or authorized for use as a critical component in life support systems or any FDA Class 3 medical devices or medical devices with a same or similar classification in a foreign jurisdiction or any devices intended for implantation in the human body. Should Buyer purchase or use **onsemi** products for any such unintended or unauthorized application, Buyer shall indemnify and hold **onsemi** and its officers, employees, subsidiaries, affiliates, and distributors harmless against all claims, costs, damages, and expenses, and reasonable attorney fees arising out of, directly or indirectly, any claim of personal injury or death associated with such unintended or unauthorized use, even if such claim alleges that **onsemi** was negligent regarding the design or manufacture of the part. **onsemi** is an Equal Opportunity/Affirmative Action Employer. This literature is subject to all applicable copyright laws and is not for resale in any manner.

ADDITIONAL INFORMATION

TECHNICAL PUBLICATIONS:

Technical Library: www.onsemi.com/design/resources/technical-documentation
onsemi Website: www.onsemi.com

ONLINE SUPPORT: www.onsemi.com/support

For additional information, please contact your local Sales Representative at www.onsemi.com/support/sales