

IRGPS40B120UD

INSULATED GATE BIPOLAR TRANSISTOR WITH
ULTRAFast SOFT RECOVERY DIODE

UltraFast Co-Pack IGBT

Features

- Non Punch Through IGBT Technology.
- Low Diode VF.
- 10µs Short Circuit Capability.
- Square RBSOA.
- Ultrasoft Diode Reverse Recovery Characteristics.
- Positive VCE (on) Temperature Coefficient.
- Super-247 Package.

Benefits

- Benchmark Efficiency for Motor Control.
- Rugged Transient Performance.
- Low EMI.
- Significantly Less Snubber Required
- Excellent Current Sharing in Parallel Operation.

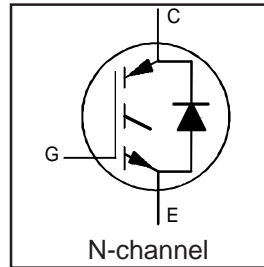

$V_{CES} = 1200V$
$V_{CE(on)} \text{ typ.} = 3.12V$
@ $V_{GE} = 15V,$
$I_{CE} = 40A, T_j = 25^\circ C$

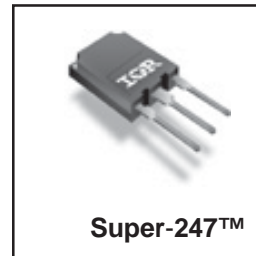

Absolute Maximum Ratings

	Parameter	Max.	Units
V_{CES}	Collector-to-Emitter Voltage	1200	V
$I_C @ T_C = 25^\circ C$	Continuous Collector Current	80	A
$I_C @ T_C = 100^\circ C$	Continuous Collector Current	40	
I_{CM}	Pulsed Collector Current	160	
I_{LM}	Clamped Inductive Load Current [Ⓞ]	160	
$I_F @ T_C = 25^\circ C$	Diode Continuous Forward Current	80	
$I_F @ T_C = 100^\circ C$	Diode Continuous Forward Current	40	
I_{FM}	Diode Maximum Forward Current	160	
V_{GE}	Gate-to-Emitter Voltage	± 20	V
$P_D @ T_C = 25^\circ C$	Maximum Power Dissipation	595	W
$P_D @ T_C = 100^\circ C$	Maximum Power Dissipation	238	
T_J	Operating Junction and	-55 to +150	°C
T_{STG}	Storage Temperature Range		
	Soldering Temperature, for 10 sec.	300 (0.063 in. (1.6mm) from case)	

Thermal Resistance

	Parameter	Min.	Typ.	Max.	Units
$R_{\theta JC}$	Junction-to-Case - IGBT	—	—	0.20	°C/W
$R_{\theta JC}$	Junction-to-Case - Diode	—	—	0.83	
$R_{\theta CS}$	Case-to-Sink, flat, greased surface	—	0.24	—	
$R_{\theta JA}$	Junction-to-Ambient, typical socket mount	—	—	40	
	Recommended Clip Force	20 (2)	—	—	N(kgf)
Wt	Weight	—	6.0 (0.21)	—	g (oz)
Le	Internal Emitter Inductance (5mm from package)	—	13	—	nH

IRGPS40B120UD

Electrical Characteristics @ T_J = 25°C (unless otherwise specified)

	Parameter	Min.	Typ.	Max.	Units	Conditions	Ref.Fig.
V _{(BR)CES}	Collector-to-Emitter Breakdown Voltage	1200	—	—	V	V _{GE} = 0V, I _C = 500μA	
ΔV _{(BR)CES} /ΔT _J	Temperature Coeff. of Breakdown Voltage	—	0.40	—	V/°C	V _{GE} = 0V, I _C = 1.0mA, (25°C-125°C)	
V _{CE(on)}	Collector-to-Emitter Saturation Voltage	—	3.12	3.40	V	I _C = 40A I _C = 50A I _C = 40A, T _J = 125°C I _C = 50A, T _J = 125°C	5, 6
		—	3.39	3.70			7, 9
		—	3.88	4.30			10
		—	4.24	4.70			11
V _{GE(th)}	Gate Threshold Voltage	4.0	5.0	6.0		V _{CE} = V _{GE} , I _C = 250μA	9,10
ΔV _{GE(th)} /ΔT _J	Temperature Coeff. of Threshold Voltage	—	-12	—	mV/°C	V _{CE} = V _{GE} , I _C = 1.0mA, (25°C-125°C)	11, 12
g _{fe}	Forward Transconductance	—	30.5	—	S	V _{CE} = 50V, I _C = 40A, PW=80μs	
I _{CES}	Zero Gate Voltage Collector Current	—	—	500	μA	V _{GE} = 0V, V _{CE} = 1200V	
		—	420	1200		V _{GE} = 0V, V _{CE} = 1200V, T _J = 125°C	
V _{FM}	Diode Forward Voltage Drop	—	2.03	2.40	V	I _C = 40A	8
		—	2.17	2.60		I _C = 50A	
		—	2.26	2.68		I _C = 40A, T _J = 125°C	
		—	2.46	2.95		I _C = 50A, T _J = 125°C	
I _{GES}	Gate-to-Emitter Leakage Current	—	—	±100	nA	V _{GE} = ±20V	

Switching Characteristics @ T_J = 25°C (unless otherwise specified)

	Parameter	Min.	Typ.	Max.	Units	Conditions	Ref.Fig.
Q _g	Total Gate Charge (turn-on)	—	340	510	nC	I _C = 40A	23
Q _{ge}	Gate - Emitter Charge (turn-on)	—	40	60		V _{CC} = 600V	CT1
Q _{gc}	Gate - Collector Charge (turn-on)	—	165	248		V _{GE} = 15V	
E _{on}	Turn-On Switching Loss	—	1400	1750	μJ	I _C = 40A, V _{CC} = 600V	CT4
E _{off}	Turn-Off Switching Loss	—	1650	2050		V _{GE} = 15V, R _G = 4.7Ω, L = 200μH	WF1
E _{tot}	Total Switching Loss	—	3050	3800	μJ	L _s = 150nH T _J = 25°C	WF2
E _{on}	Turn-On Switching Loss	—	1950	2300		T _J = 125°C	13,15
E _{off}	Turn-Off Switching Loss	—	2200	2950	μJ	Energy losses include "tail" and diode reverse recovery.	
E _{tot}	Total Switching Loss	—	4150	5250			
t _{d(on)}	Turn-On Delay Time	—	76	99	ns	I _C = 40A, V _{CC} = 600V	14, 16
t _r	Rise Time	—	39	55		V _{GE} = 15V, R _G = 4.7Ω, L = 200μH	CT4
t _{d(off)}	Turn-Off Delay Time	—	332	365		L _s = 150nH, T _J = 125°C	WF1
t _f	Fall Time	—	25	33			WF2
C _{ies}	Input Capacitance	—	4300	—	pF	V _{GE} = 0V	22
C _{oes}	Output Capacitance	—	330	—		V _{CC} = 30V	
C _{res}	Reverse Transfer Capacitance	—	160	—		f = 1.0MHz	
RBSOA	Reverse Bias Safe Operating Area	FULL SQUARE				T _J = 150°C, I _C = 160A, V _p = 1200V V _{CC} = 1000V, V _{GE} = +15V to 0V R _G = 4.7Ω	4 CT2
SCSOA	Short Circuit Safe Operating Area	10	—	—	μs	T _J = 150°C, V _p = 1200V V _{CC} = 900V, V _{GE} = +15V to 0V, R _G = 4.7Ω	CT3 WF4
E _{rec}	Reverse Recovery energy of the diode	—	3346	—	μJ	T _J = 125°C	17,18,19
t _{rr}	Diode Reverse Recovery time	—	180	—	ns	V _{CC} = 600V, I _F = 60A, L = 200μH	20, 21
I _{rr}	Diode Peak Reverse Recovery Current	—	50	—	A	V _{GE} = 15V, R _G = 4.7Ω, L _s = 150nH	CT4, WF3

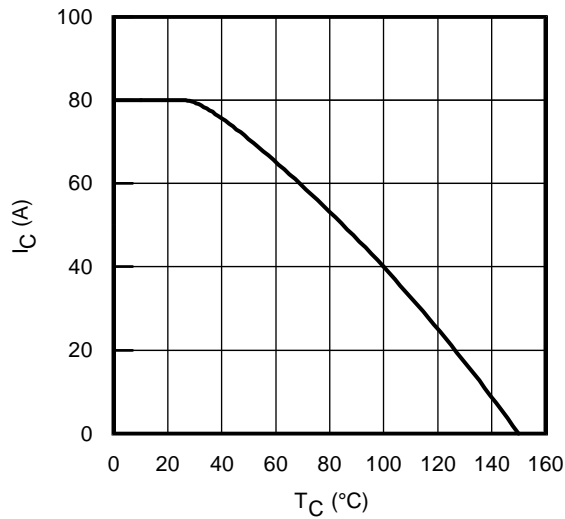

Fig. 1 - Maximum DC Collector Current vs. Case Temperature

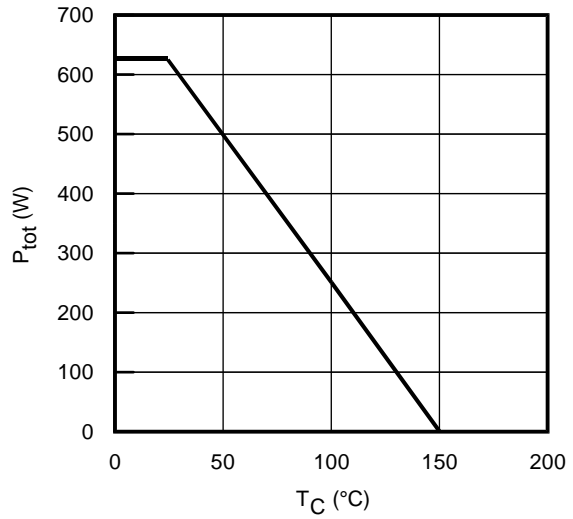

Fig. 2 - Power Dissipation vs. Case Temperature

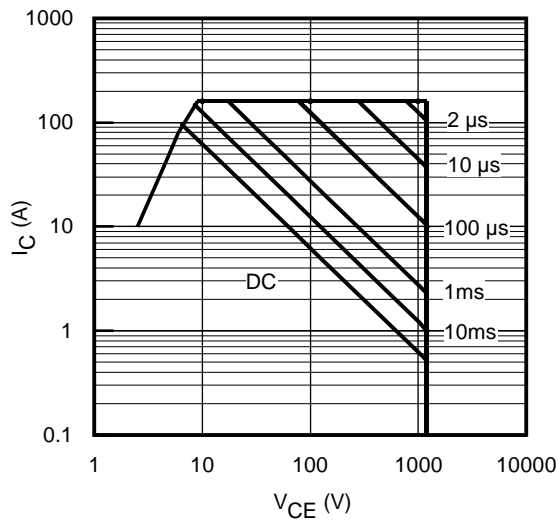

Fig. 3 - Forward SOA
 $T_C = 25^\circ\text{C}$; $T_{JS} \leq 150^\circ\text{C}$

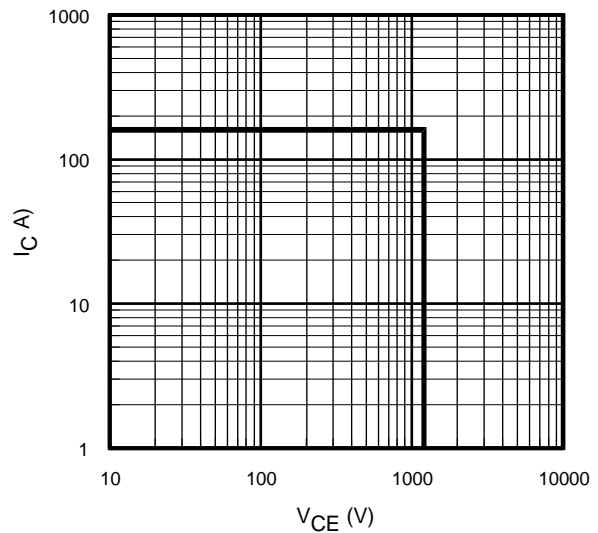

Fig. 4 - Reverse Bias SOA
 $T_J = 150^\circ\text{C}$; $V_{GE} = 15\text{V}$

IRGPS40B120UD

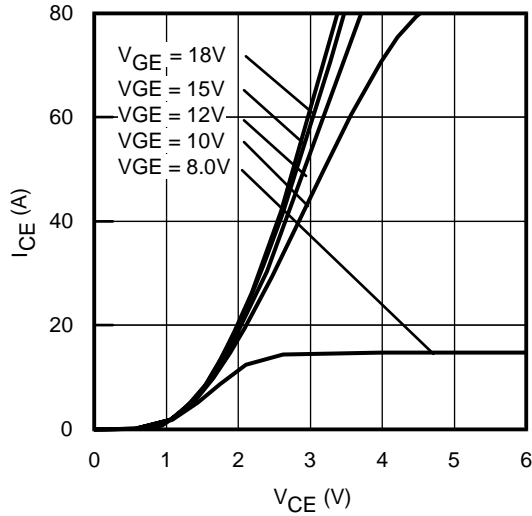

Fig. 5 - Typ. IGBT Output Characteristics
 $T_J = -40^\circ\text{C}$; $t_p = 80\mu\text{s}$

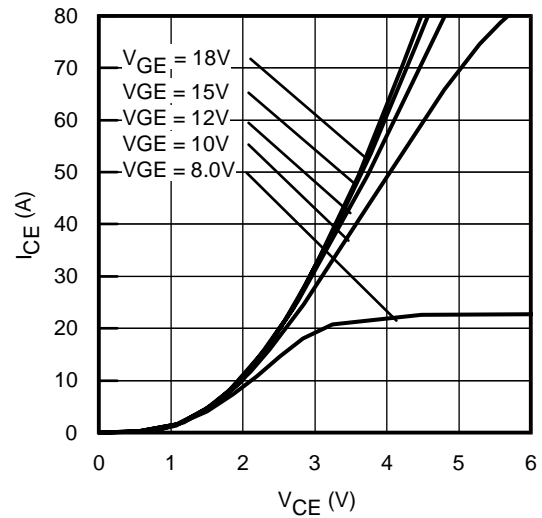

Fig. 6 - Typ. IGBT Output Characteristics
 $T_J = 25^\circ\text{C}$; $t_p = 80\mu\text{s}$

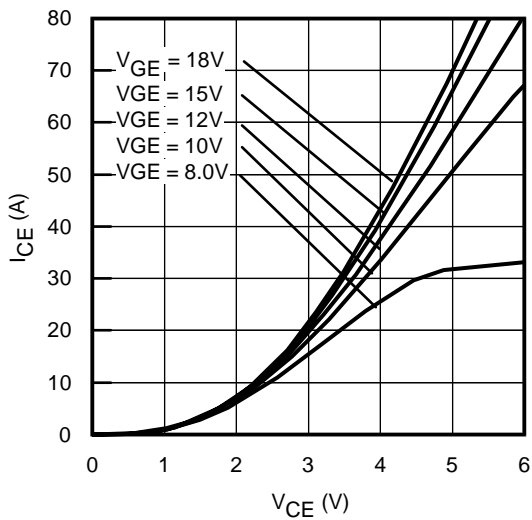

Fig. 7 - Typ. IGBT Output Characteristics
 $T_J = 125^\circ\text{C}$; $t_p = 80\mu\text{s}$

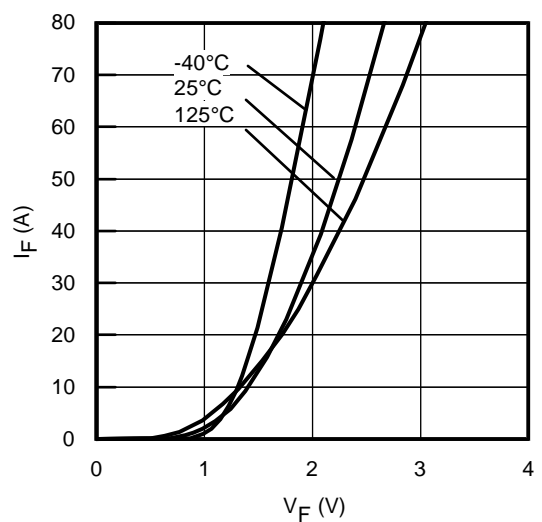

Fig. 8 - Typ. Diode Forward Characteristics
 $t_p = 80\mu\text{s}$

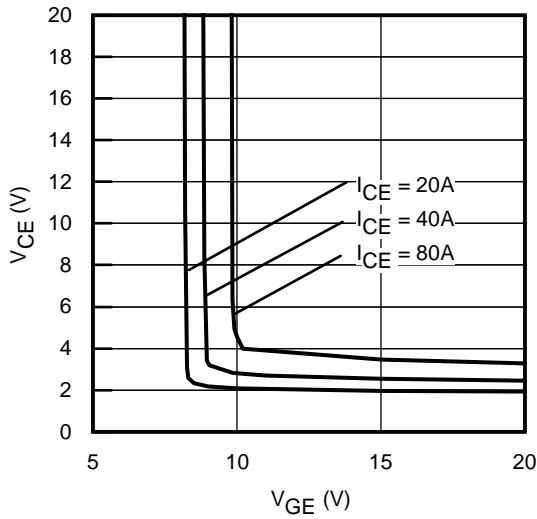

Fig. 9 - Typical V_{CE} vs. V_{GE}
 $T_J = -40^\circ\text{C}$

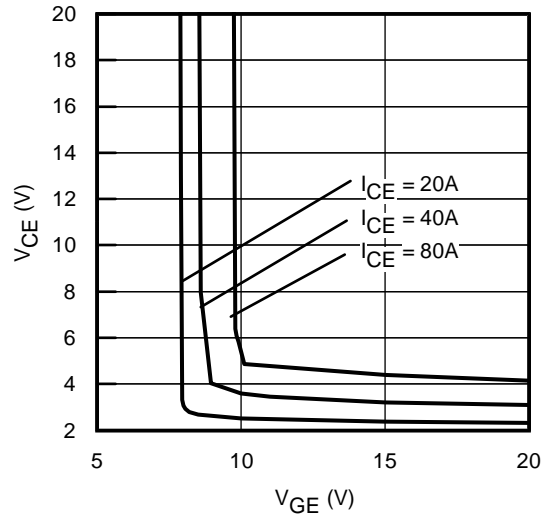

Fig. 10 - Typical V_{CE} vs. V_{GE}
 $T_J = 25^\circ\text{C}$

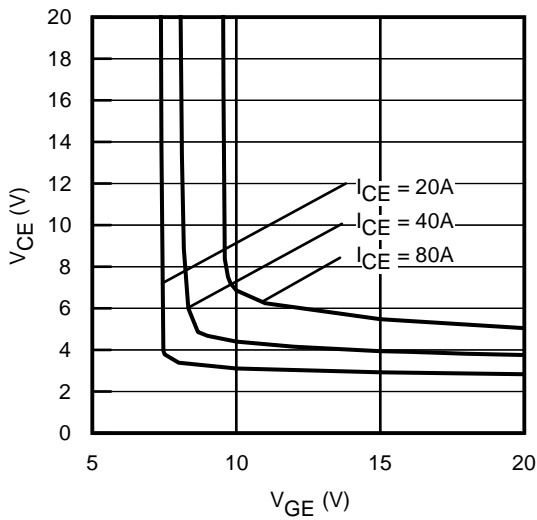

Fig. 11 - Typical V_{CE} vs. V_{GE}
 $T_J = 125^\circ\text{C}$

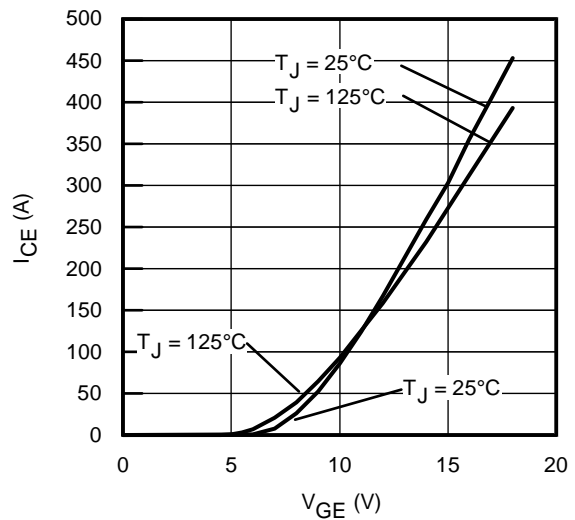

Fig. 12 - Typ. Transfer Characteristics
 $V_{CE} = 50\text{V}$; $t_p = 10\mu\text{s}$

IRGPS40B120UD

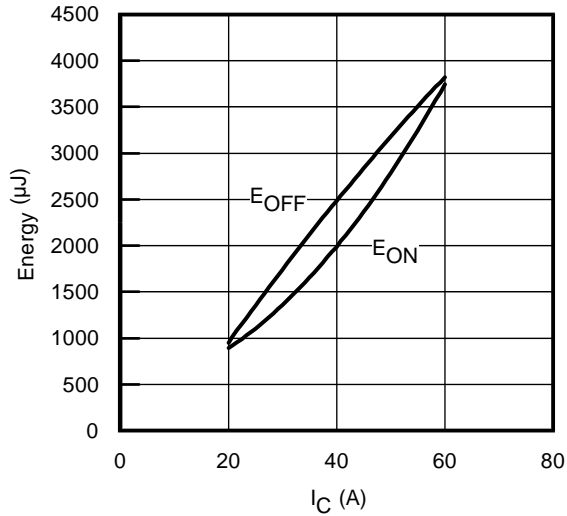

Fig. 13 - Typ. Energy Loss vs. I_C
 $T_J = 125^\circ\text{C}$; $L=200\mu\text{H}$; $V_{CE}= 600\text{V}$
 $R_G= 4.7\Omega$; $V_{GE}= 15\text{V}$

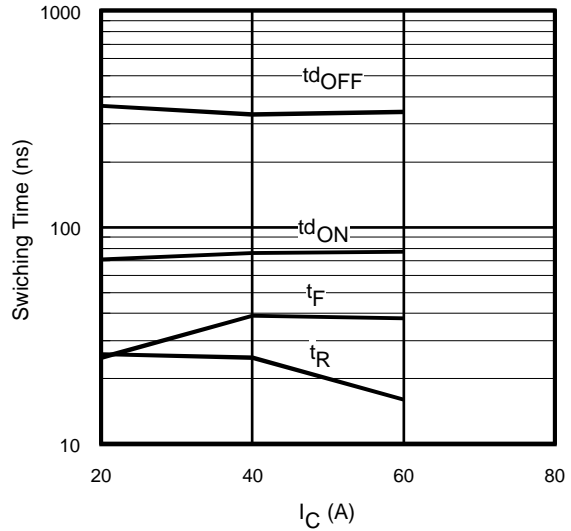

Fig. 14 - Typ. Switching Time vs. I_C
 $T_J = 125^\circ\text{C}$; $L=200\mu\text{H}$; $V_{CE}= 600\text{V}$
 $R_G= 4.7\Omega$; $V_{GE}= 15\text{V}$

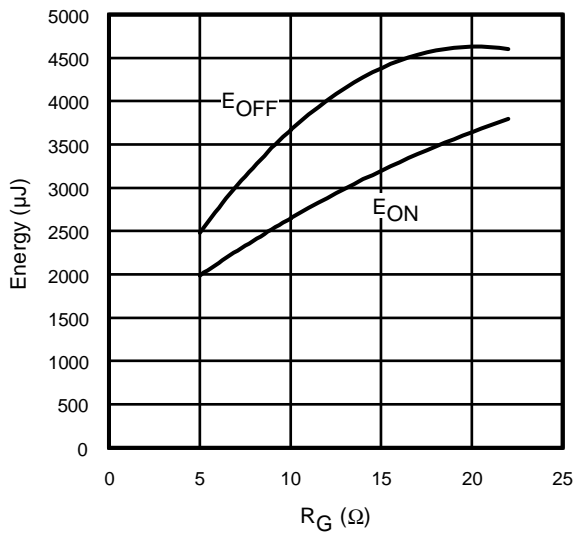

Fig. 15 - Typ. Energy Loss vs. R_G
 $T_J = 125^\circ\text{C}$; $L=200\mu\text{H}$; $V_{CE}= 600\text{V}$
 $I_{CE}= 40\text{A}$; $V_{GE}= 15\text{V}$

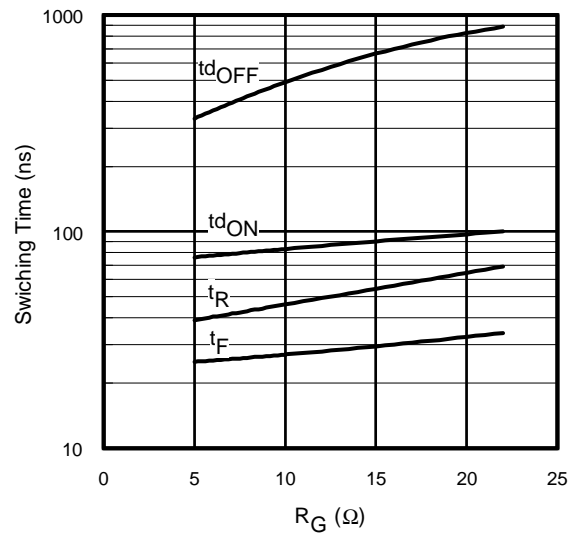

Fig. 16 - Typ. Switching Time vs. R_G
 $T_J = 125^\circ\text{C}$; $L=200\mu\text{H}$; $V_{CE}= 600\text{V}$
 $I_{CE}= 40\text{A}$; $V_{GE}= 15\text{V}$

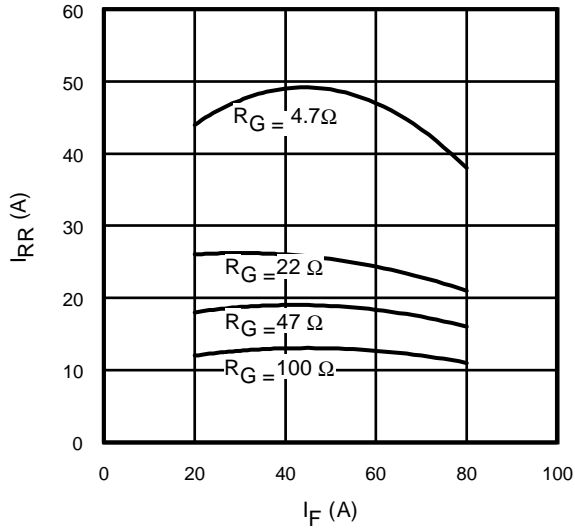

Fig. 17 - Typical Diode I_{RR} vs. I_F
 $T_J = 125^\circ\text{C}$

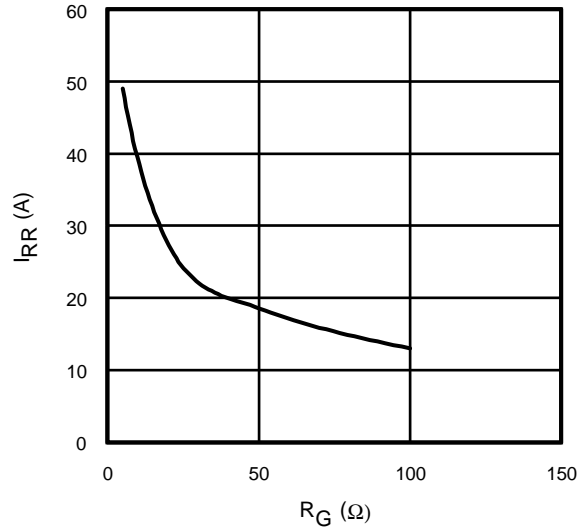

Fig. 18 - Typical Diode I_{RR} vs. R_G
 $T_J = 125^\circ\text{C}; I_F = 40\text{A}$

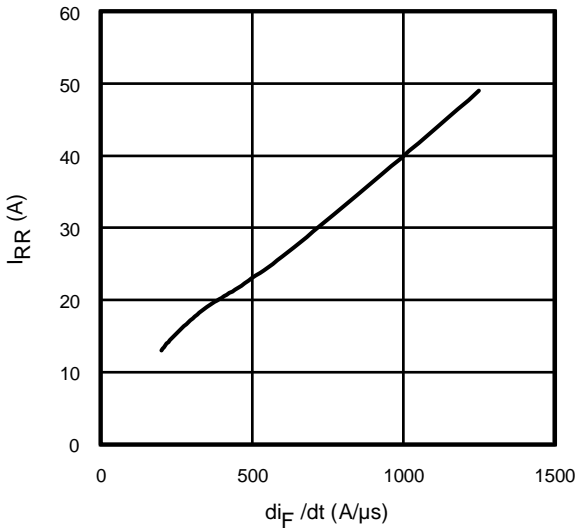

Fig. 19- Typical Diode I_{RR} vs. di_F/dt
 $V_{CC} = 600\text{V}; V_{GE} = 15\text{V};$
 $I_{CE} = 40\text{A}; T_J = 125^\circ\text{C}$

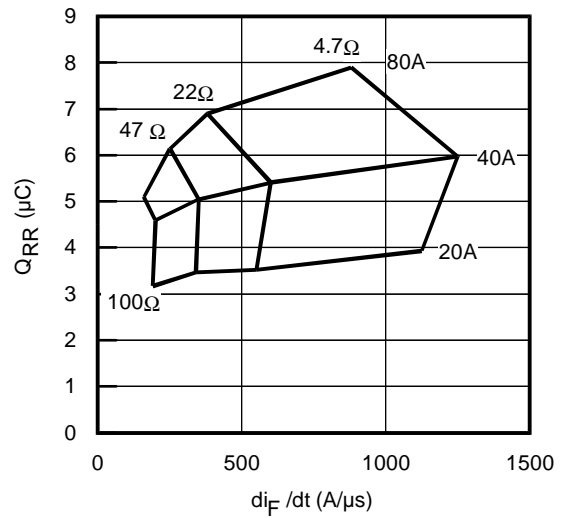

Fig. 20 - Typical Diode Q_{RR}
 $V_{CC} = 600\text{V}; V_{GE} = 15\text{V}; T_J = 125^\circ\text{C}$

IRGPS40B120UD

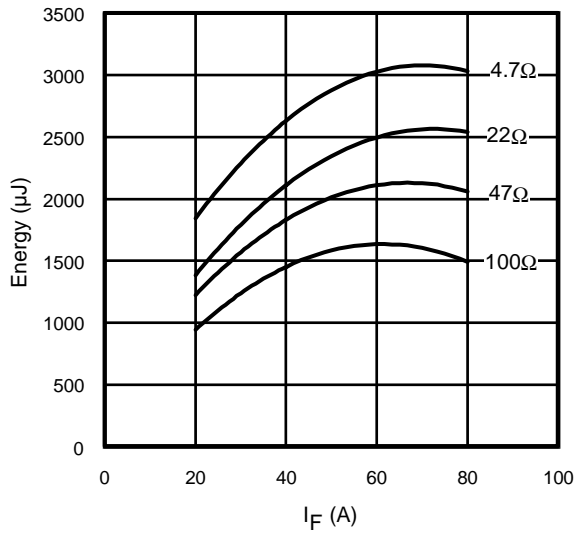

Fig. 21 - Typical Diode E_{RR} vs. I_F
 $T_J = 125^\circ\text{C}$

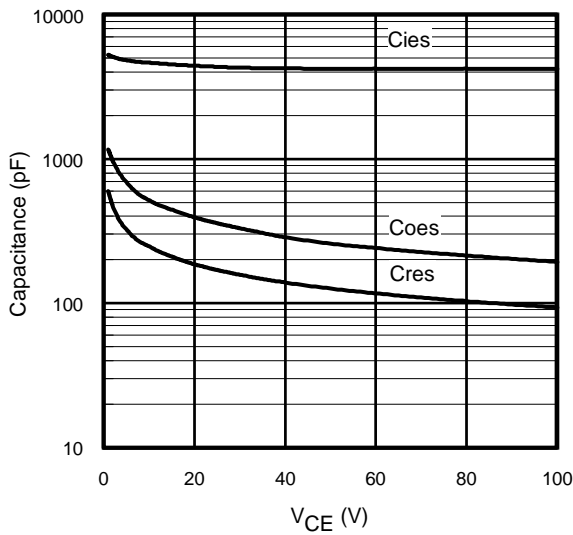

Fig. 22- Typ. Capacitance vs. V_{CE}
 $V_{GE} = 0\text{V}$; $f = 1\text{MHz}$

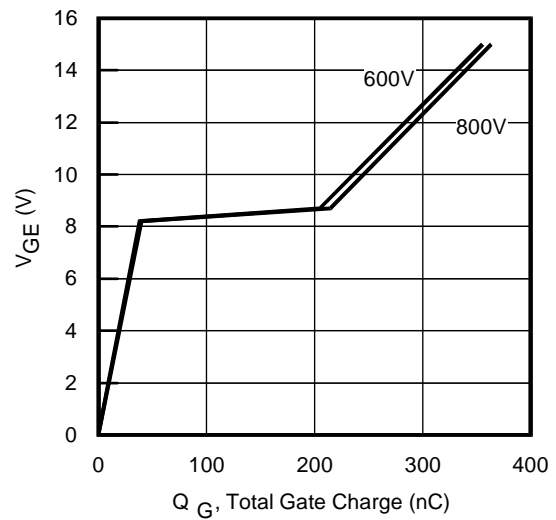

Fig. 23 - Typical Gate Charge vs. V_{GE}
 $I_{CE} = 40\text{A}$; $L = 600\mu\text{H}$

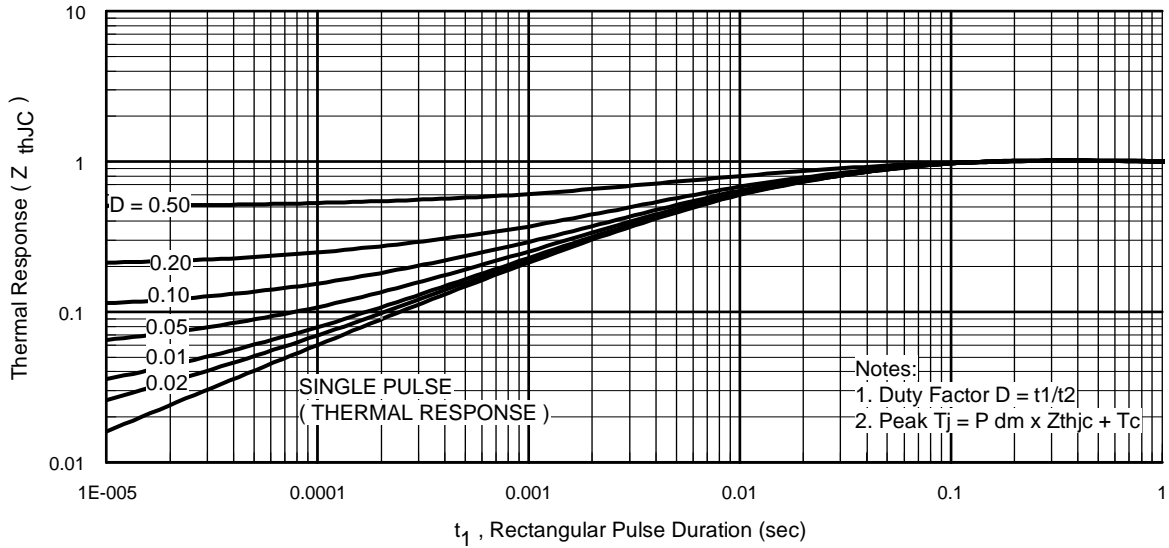

Fig 24. Normalized Transient Thermal Impedance, Junction-to-Case (IGBT)

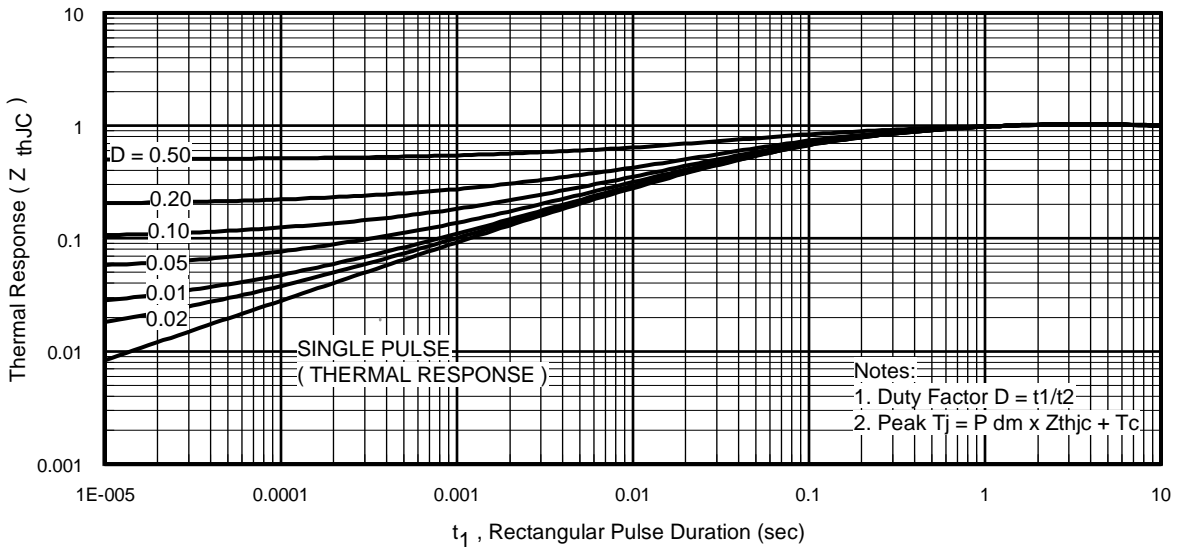

Fig 25. Normalized Transient Thermal Impedance, Junction-to-Case (DIODE)

IRGPS40B120UD

International
IR Rectifier

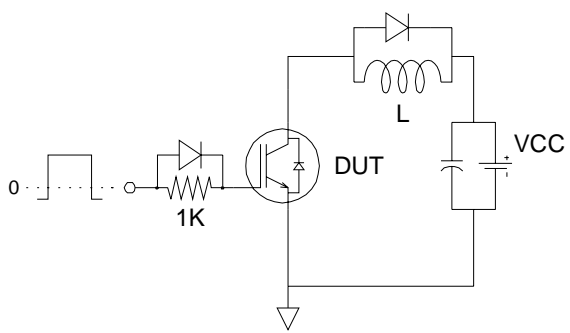

Fig.C.T.1 - Gate Charge Circuit (turn-on)

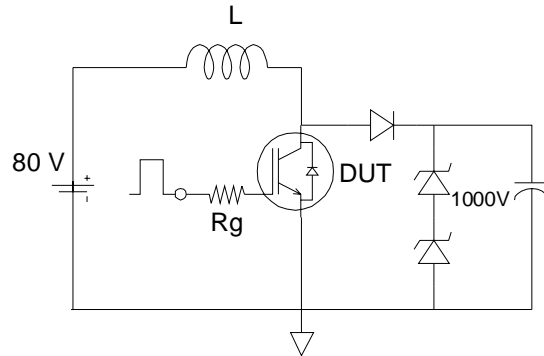

Fig.C.T.2 - RBSOA Circuit

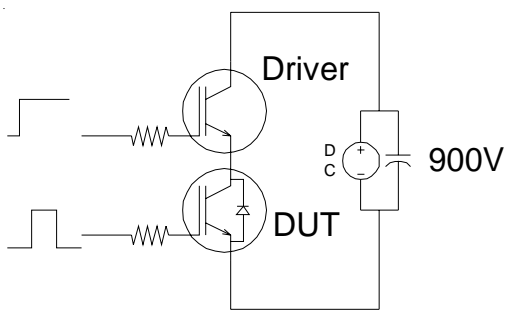

Fig.C.T.3 - RBSOA Circuit

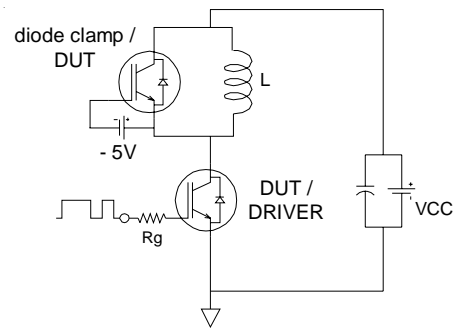

Fig.C.T.4 - RBSOA Circuit

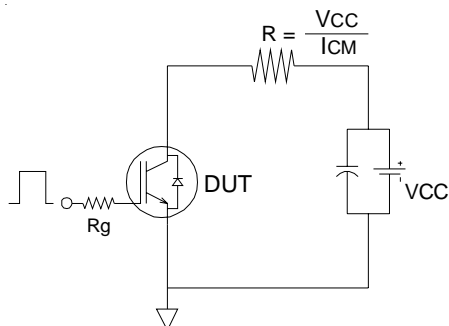

Fig.C.T.5 - RBSOA Circuit

Fig. WF.1 - Typ. Turn-off Loss Waveform
 @ $T_j=125^\circ\text{C}$ using Fig. CT.4

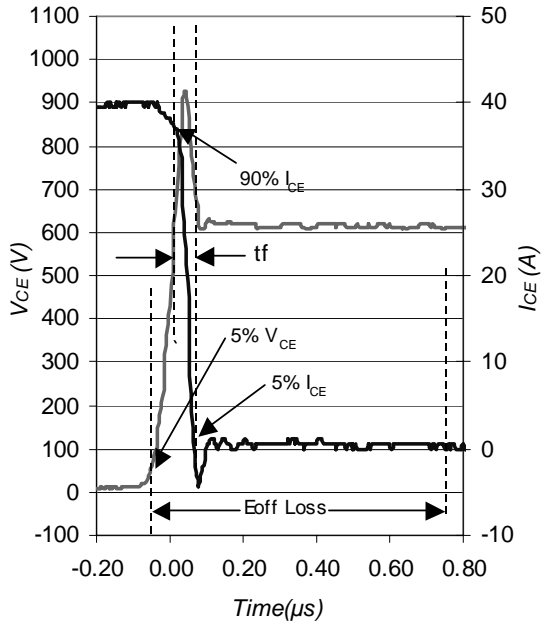

Fig. WF.2 - Typ. Turn-on Loss Waveform
 @ $T_j=125^\circ\text{C}$ using Fig. CT.4

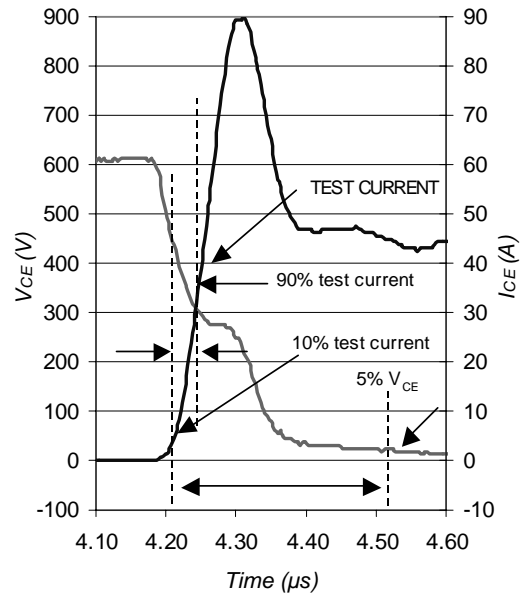

Fig. WF.3 - Typ. Diode Recovery Waveform
 @ $T_j=125^\circ\text{C}$ using Fig. CT.4

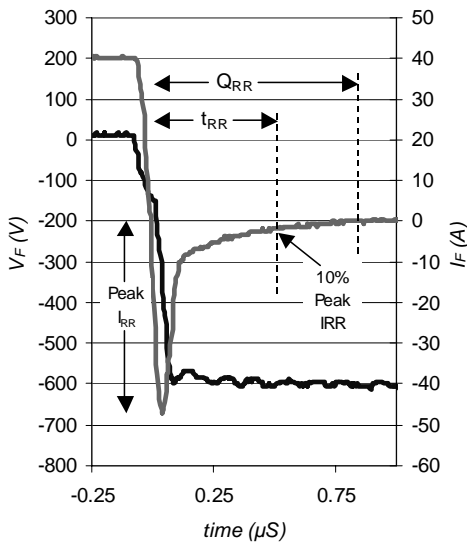

Fig. WF.4 - Typ. S.C. Waveform
 @ $T_C=150^\circ\text{C}$ using Fig. CT.3

