

Fuji Discrete Package IGBT

■ Outline Drawing

■ Features

- Square RBSOA
- Low Saturation Voltage
- Less Total Power Dissipation
- Minimized Internal Stray Inductance

■ Applications

- High Power Switching
- A.C. Motor Controls
- D.C. Motor Controls
- Uninterruptible Power Supply

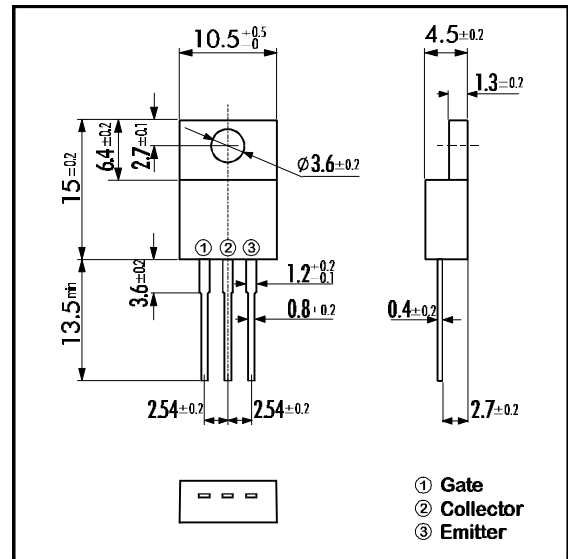

■ Maximum Ratings and Characteristics

• Absolute Maximum Ratings (T_c=25°C)

Items	Symbols	Ratings	Units
Collector-Emitter Voltage	V _{CES}	600	V
Gate -Emitter Voltage	V _{GES}	± 20	V
Collector Current	DC T _c = 25°C	I _{C 25}	13
	DC T _c =100°C	I _{C 100}	5
	1ms T _c = 25°C	I _{C PULSE}	52
IGBT Max. Power Dissipation	P _C	50	W
FWD Max. Power Dissipation	P _C	25	W
Operating Temperature	T _j	+150	°C
Storage Temperature	T _{stg}	-40 ~ +125	°C
Mounting Screw Torque		40	Nm

■ Equivalent Circuit

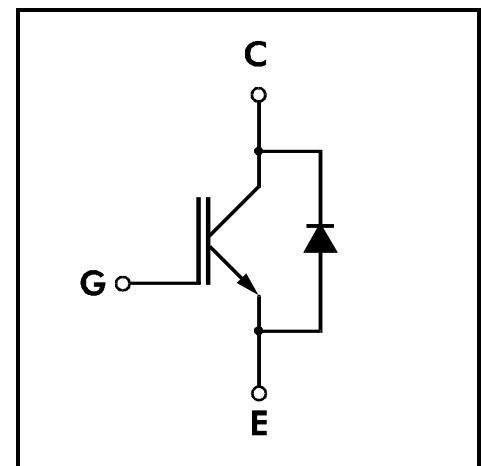

• Electrical Characteristics (at T_j=25°C)

Items	Symbols	Test Conditions	Min.	Typ.	Max.	Units	
Zero Gate Voltage Collector Current	I _{CES}	V _{GE} =0V V _{CE} =600V			1.0	mA	
Gate-Emitter Leakage Current	I _{GES}	V _{CE} =0V V _{GE} =± 20V			20	μA	
Gate-Emitter Threshold Voltage	V _{GE(th)}	V _{GE} =20V I _C =5mA	5.5		8.5	V	
Collector-Emitter Saturation Voltage	V _{CE(sat)}	V _{GE} =15V I _C =5A			3.0	V	
Input capacitance	C _{ies}	V _{GE} =0V		400		pF	
Output capacitance	C _{oes}	V _{CE} =10V		85			
Reverse Transfer capacitance	C _{res}	f=1MHz		15			
Switching Time	Turn-on Time	t _{ON}	V _{CC} =300V			1.2	μs
		t _r	I _C =5A			0.6	
	Turn-off Time	t _{OFF}	V _{GE} =±15V			1.0	
		t _f	R _G =330Ω			0.35	
	Turn-on Time	t _{ON}	V _{CC} =300V		0.16		μs
		t _r	I _C =5A		0.11		
	Turn-off Time	t _{OFF}	V _{GE} =+15V		0.30		
		t _f	R _G =33Ω			0.35	
Diode Forward On-Voltage	V _F	I _F =5A V _{GE} =0V			3.0	V	
Reverse Recovery Time	t _{rr}	I _F =5A, V _{GE} =-10V, di/dt=100A/μs			300	ns	

• Thermal Characteristics

Items	Symbols	Test Conditions	Min.	Typ.	Max.	Units
Thermal Resistance	R _{th(j-c)}	IGBT			2.50	°C/W
	R _{th(j-e)}	Diode			5.00	

Collector Current vs. Collector-Emitter Voltage

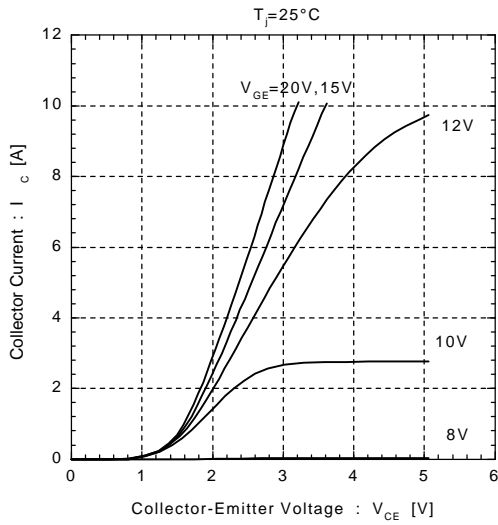

Collector Current vs. Collector-Emitter Voltage

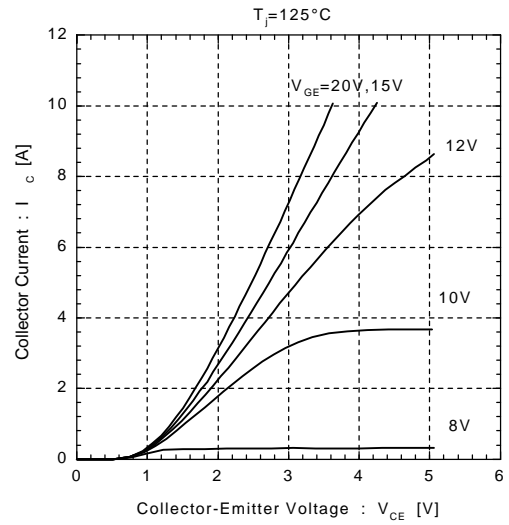

Collector-Emitter Voltage vs. Gate-Emitter Voltage

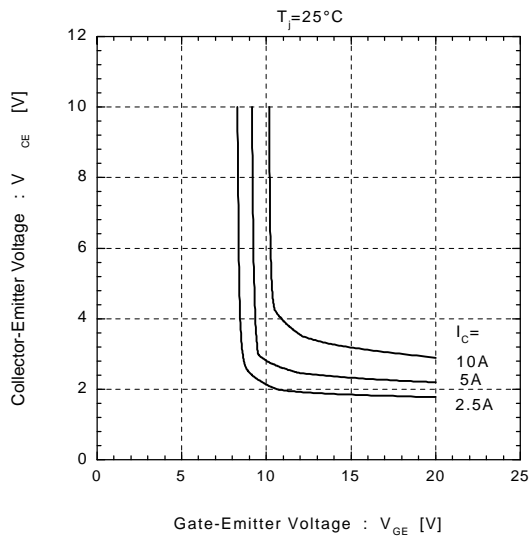

Collector-Emitter Voltage vs. Gate-Emitter Voltage

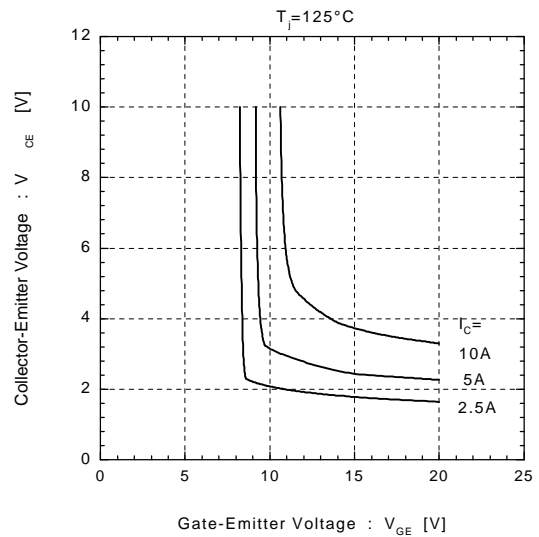

Switching Time vs. Collector Current

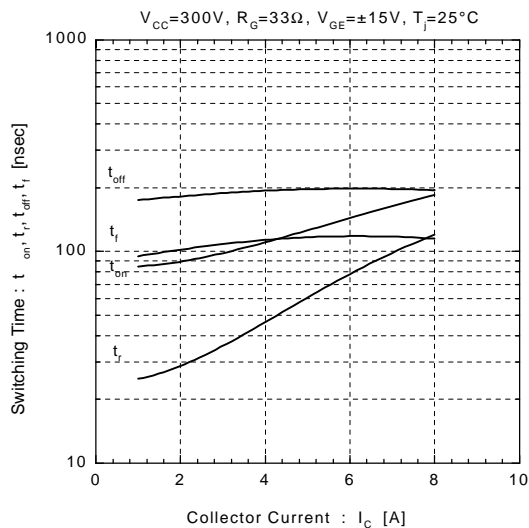

Switching Time vs. Collector Current

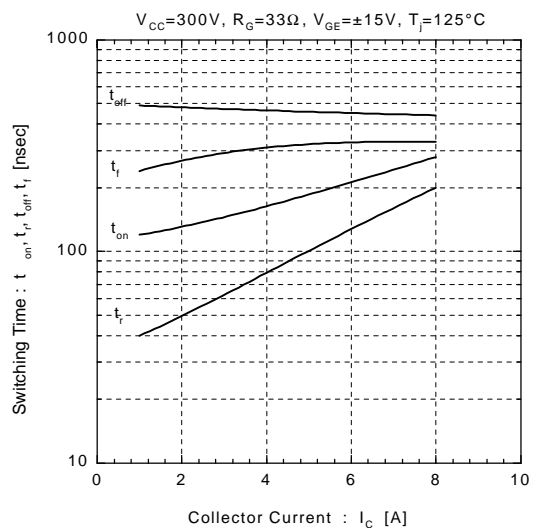

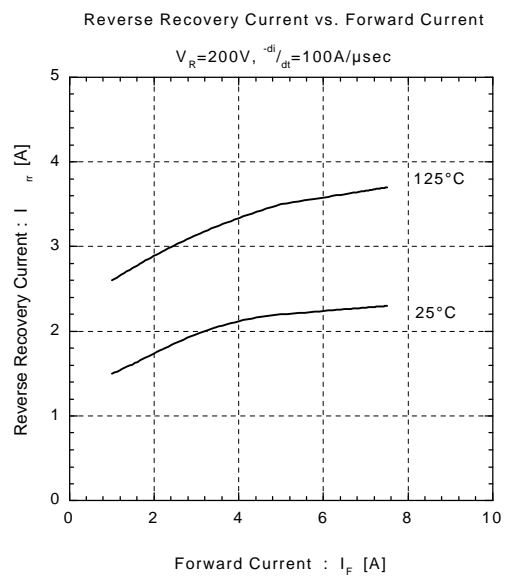
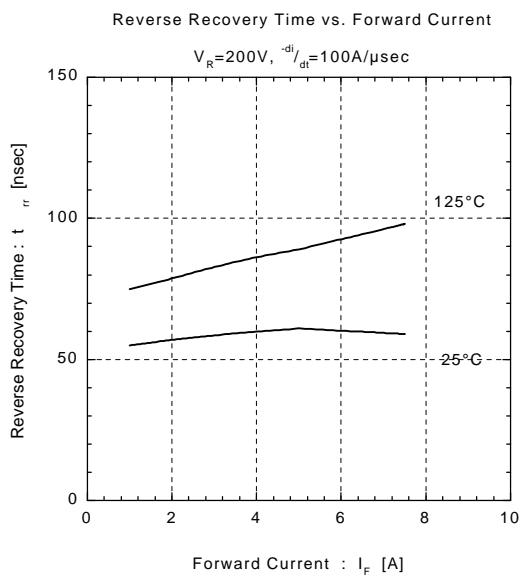
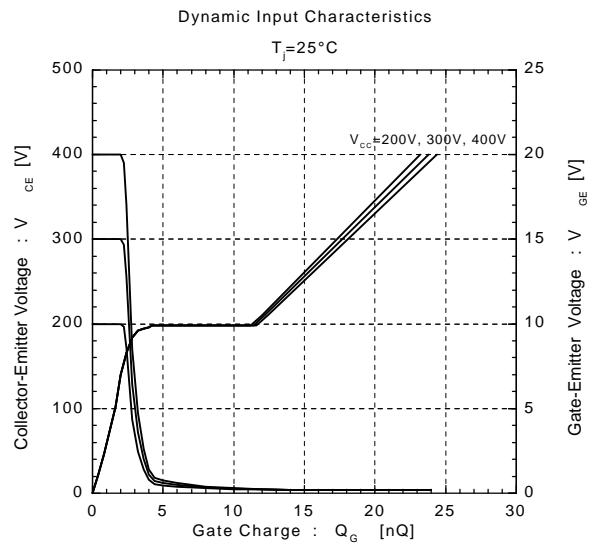
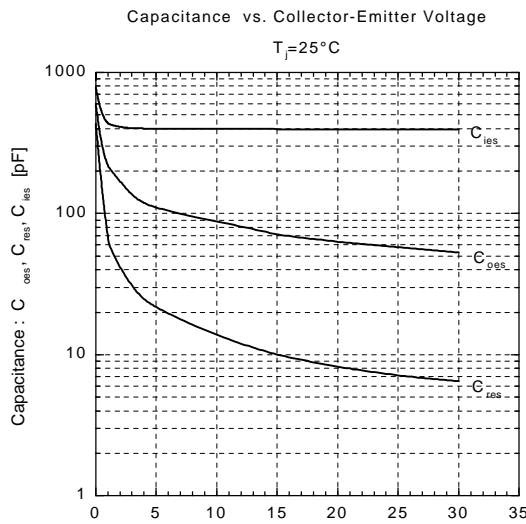
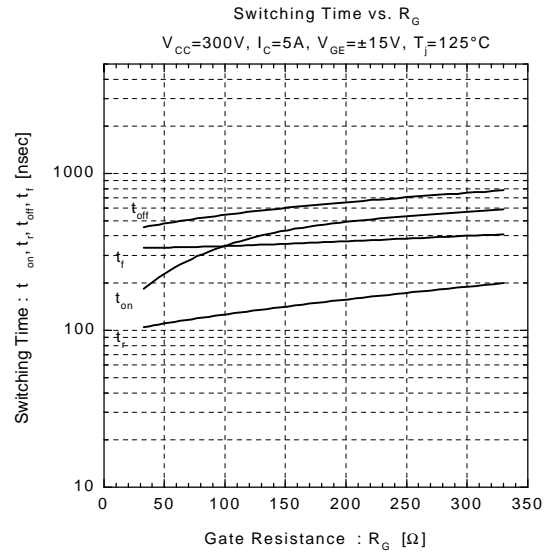
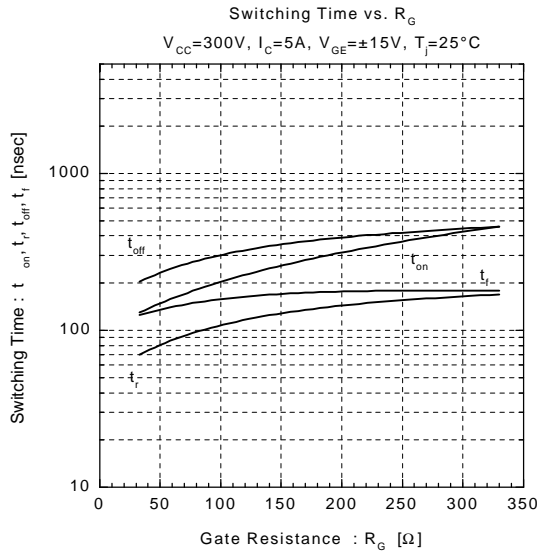

Reverse Biased Safe Operating Area
+V_{GE}=15V, -V_{GE}≤15V, T_J≤125°C, R_G≥33Ω

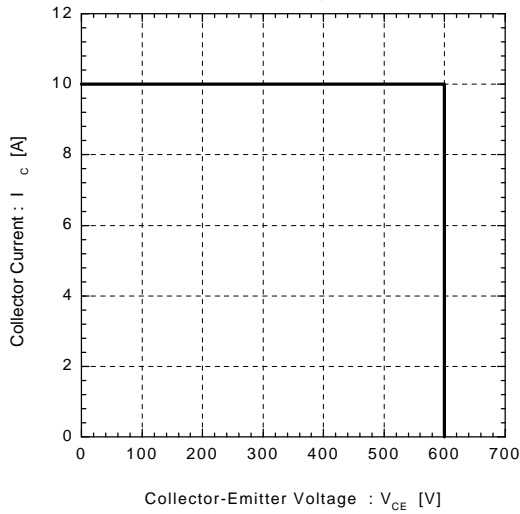

Typical Short Circuit Capability
V_{CC}=400V, R_G=33Ω, T_J=125°C

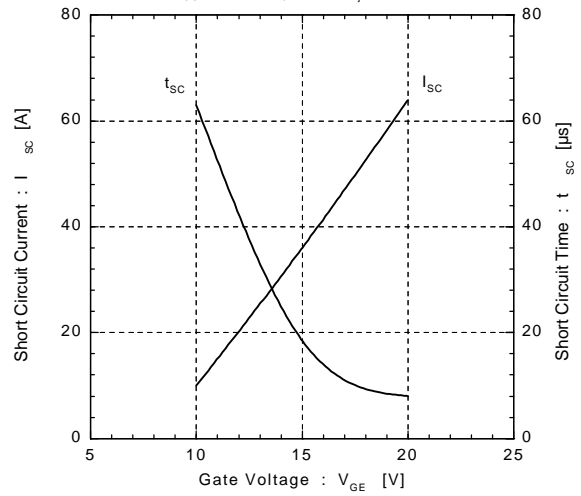

Forward Voltage vs. Forward Current

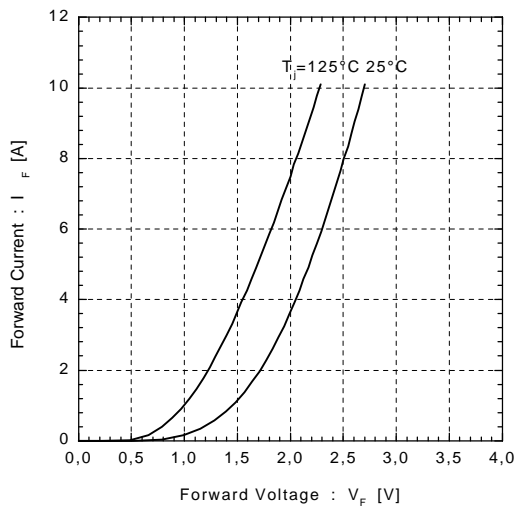

Reverse Recovery Characteristics vs. -di/dt
I_F=5A, T_J=125°C

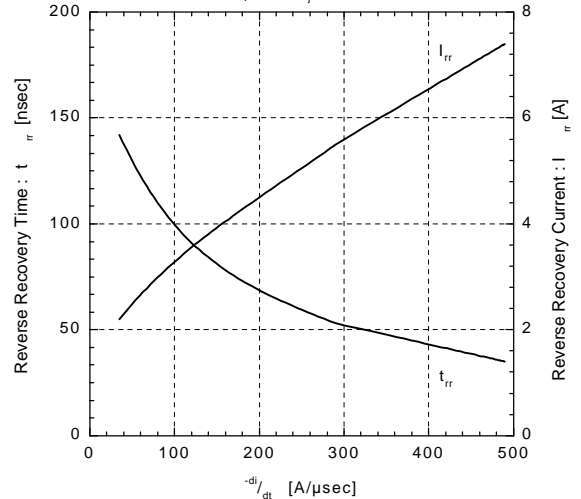

Transient Thermal Resistance

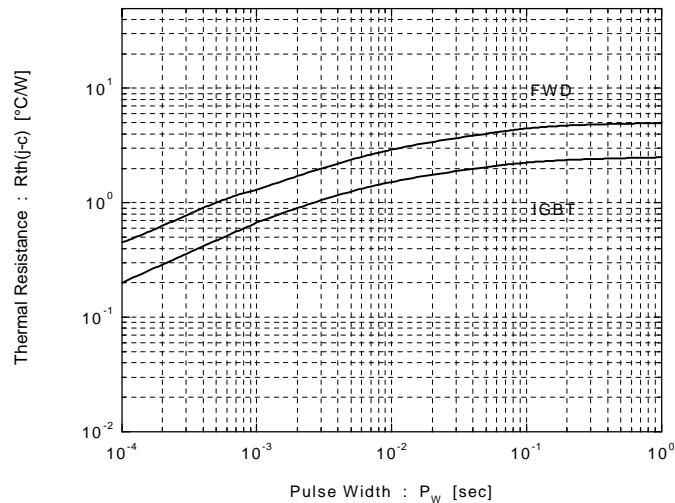

Switching losses (E_{on} , E_{off} vs. I_c)

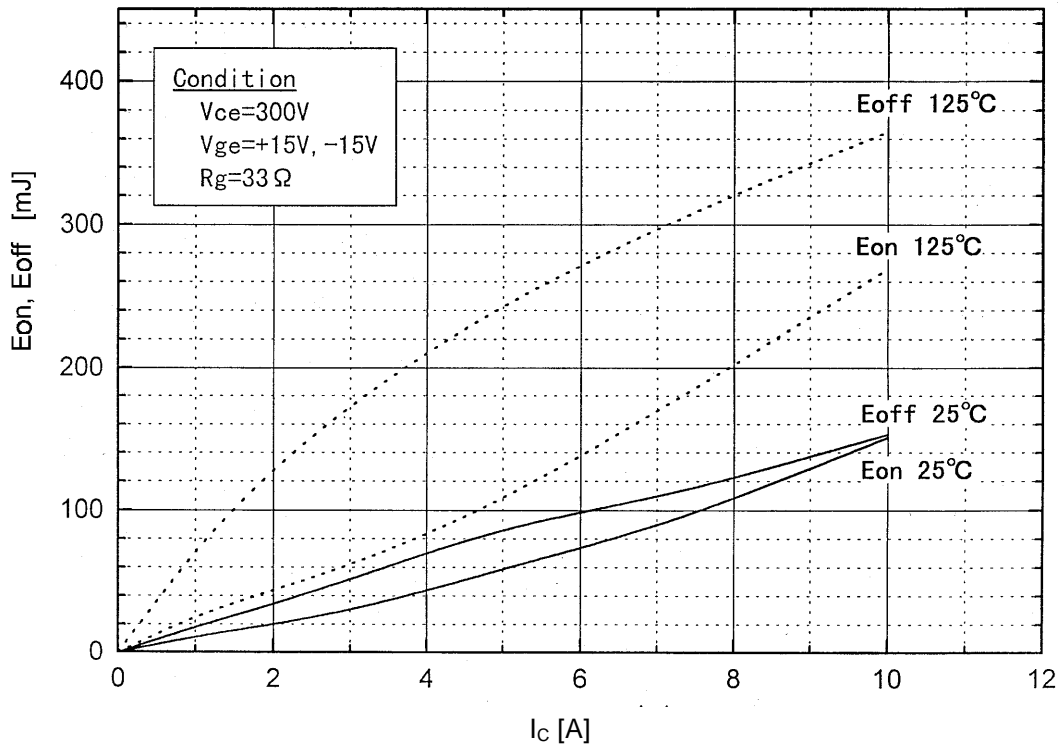

Test Circuit

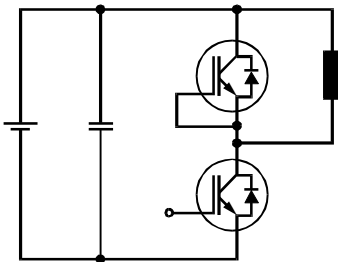

Switching waveforms

