

Pb Free Plating Product

MUR15120



15 Ampere, 1200 Volt SwitchMode Single Fast Recovery Epitaxial Diode

APPLICATION

- Freewheeling, Snubber, Clamp
- Inversion Welder
- PFC
- Plating Power Supply
- Ultrasonic Cleaner and Welder
- Converter & Chopper
- UPS

PRODUCT FEATURE

- Ultrafast Recovery Time
- Soft Recovery Characteristics
- Low Recovery Loss
- Low Forward Voltage
- High Surge Current Capability
- Low Leakage Current

TO-220AC/TO-220C-2P

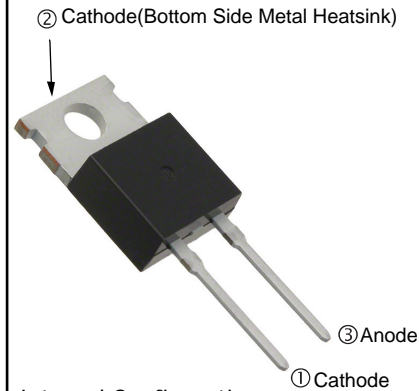

Internal Configuration

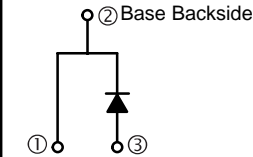

GENERAL DESCRIPTION

MUR15120 using the latest FRED FAB process(planar passivation chip) with ultrafast and soft recovery characteristic.

ABSOLUTE MAXIMUM RATINGS

$T_C = 25^\circ\text{C}$ unless otherwise specified

Symbol	Parameter/Test Conditions		Values	Unit
V_R	Maximum D.C. Reverse Voltage		1200	V
V_{RRM}	Maximum Repetitive Reverse Voltage			
$I_{F(AV)}$	Average Forward Current	$T_C = 100^\circ\text{C}$	15	A
$I_{F(RMS)}$	RMS Forward Current	$T_C = 100^\circ\text{C}$	21	
I_{FSM}	Non Repetitive Surge Forward Current	$T_J = 45^\circ\text{C}, t = 10\text{ms}, 50\text{Hz}, \text{Sine}$	150	
P_D	Power Dissipation		125	W
T_J	Junction Temperature		-55 to +150	$^\circ\text{C}$
T_{STG}	Storage Temperature Range		-55 to +125	$^\circ\text{C}$
Torque	Module to Sink	Recommended (M3)	1.1	Nm
R_{thJC}	Junction to Case Thermal Resistance		1.0	$^\circ\text{C/W}$
Weight			2.5	g

ELECTRICAL CHARACTERISTICS

$T_C = 25^\circ\text{C}$ unless otherwise specified

Symbol	Parameter/Test Conditions		Min.	Typ.	Max.	Unit
I_{RM}	Maximum Reverse Leakage Current				10	μA
					1	mA
V_F	Forward Voltage			2.8	3.2	V
				2.3		
t_{rr}	Reverse Recovery Time ($I_F = 1\text{A}, dI_F/dt = -200\text{A}/\mu\text{s}, V_R = 30\text{V}$)			25	30	ns
t_{rr}	Reverse Recovery Time ($I_F = 0.5\text{A}, I_R = 1\text{A}, I_{RR} = 0.25\text{A}$)			35	40	ns
t_{rr}	Reverse Recovery Time			72		ns
I_{RRM}	Maximum Reverse Recovery Current			5		A
t_{rr}	Reverse Recovery Time			240		ns
I_{RRM}	Maximum Reverse Recovery Current			7.5		A

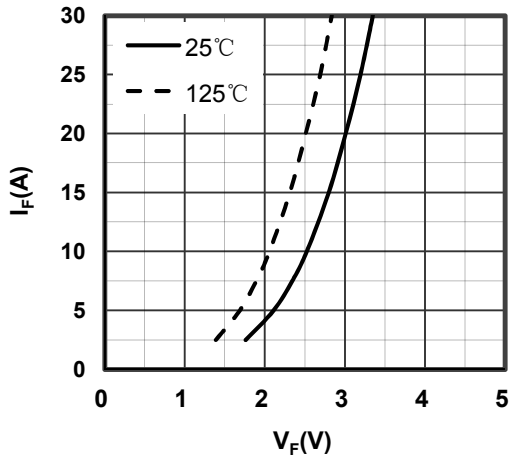

Figure 1. Forward Voltage Drop vs Forward Current

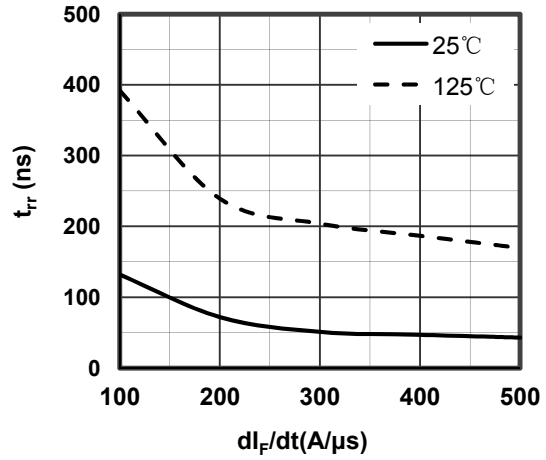

Figure 2. Reverse Recovery Time vs di_F/dt

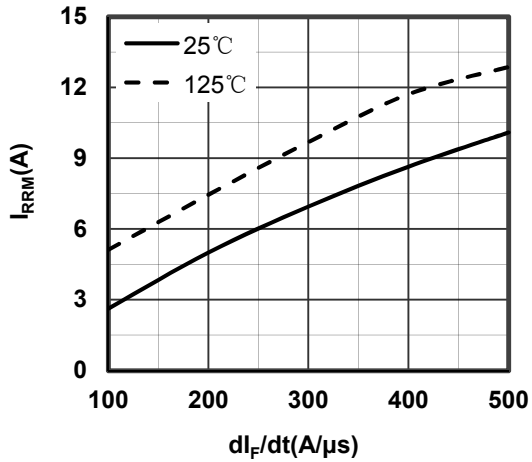

Figure 3. Reverse Recovery Current vs di_F/dt

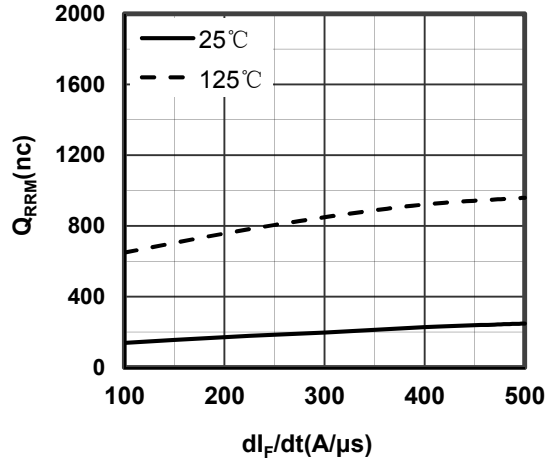

Figure 4. Reverse Recovery Charge vs di_F/dt

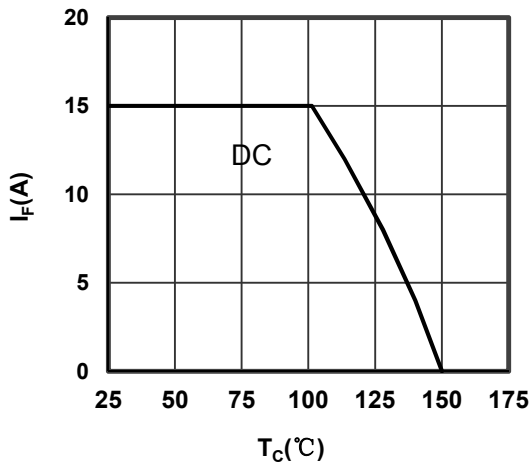

Figure 5. Forward current vs Case temperature

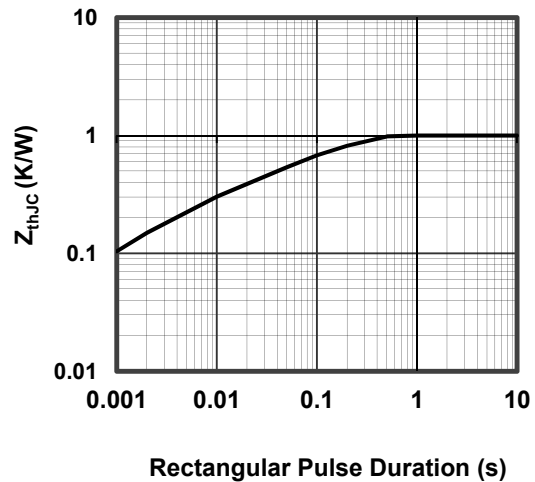

Figure 6. Transient Thermal Impedance

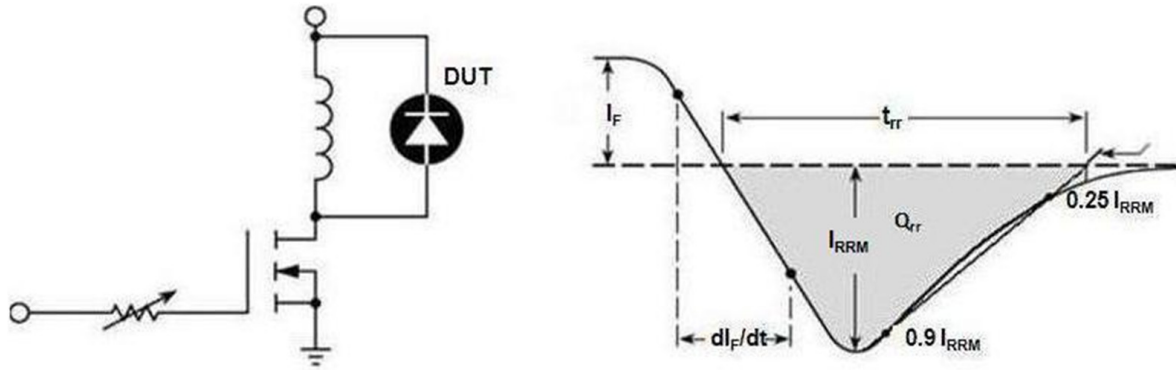
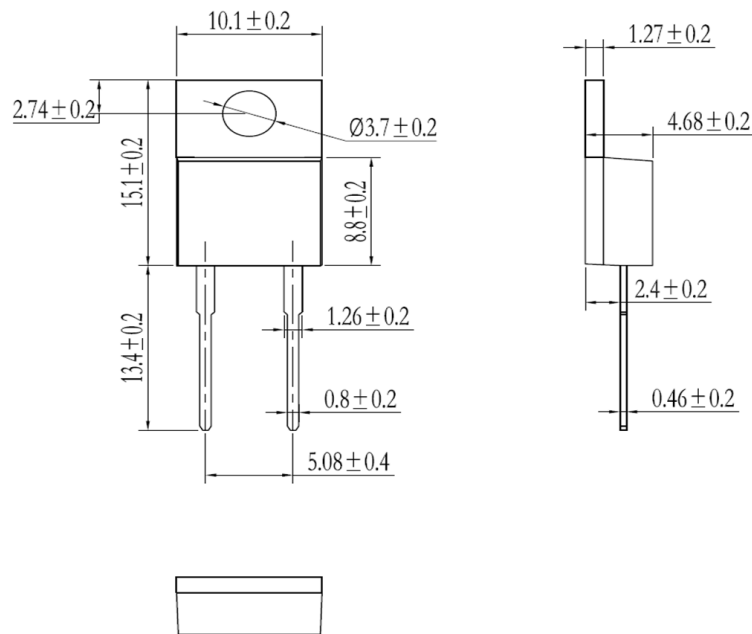

Figure 7. Diode Reverse Recovery Test Circuit and Waveform



Dimensions in (mm)
Figure 8. Package Outline