

General Description

The GreenMOS[®] high voltage MOSFET utilizes charge balance technology to achieve outstanding low on-resistance and lower gate charge. It is engineered to minimize conduction loss, provide superior switching performance and robust avalanche capability.

The GreenMOS[®] E series is optimized for its switching characteristics to achieve balance between EMI and efficiency. It is designed to enable power supply systems to reach the highest efficiency while still meeting EMI standards.

Features

- Low $R_{DS(ON)}$ & FOM
- Extremely low switching loss
- Excellent stability and uniformity
- EMI and performance balanced



Applications

- LED lighting
- Charger
- Adapter
- TV power
- Telecom power
- Server power
- Solar/UPS

Key Performance Parameters

Parameter	Value	Unit
V_{DS}	650	V
I_D , pulse	33	A
$R_{DS(ON)}$, max @ $V_{GS}=10V$	380	m Ω
Q_g	15	nC

Marking Information

Product Name	Package	Marking
OSG65R380FEF	TO220F	OSG65R380FE

Package & Pin Information

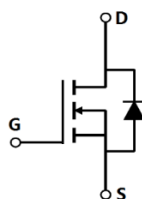

Absolute Maximum Ratings at $T_j=25^{\circ}\text{C}$ unless otherwise noted

Parameter	Symbol	Value	Unit
Drain-source voltage	V_{DS}	650	V
Gate-source voltage	V_{GS}	± 30	V
Continuous drain current ¹⁾ , $T_C=25^{\circ}\text{C}$	I_D	11	A
Continuous drain current ¹⁾ , $T_C=100^{\circ}\text{C}$		7	
Pulsed drain current ²⁾ , $T_C=25^{\circ}\text{C}$	$I_{D, pulse}$	33	A
Continuous diode forward current ¹⁾ , $T_C=25^{\circ}\text{C}$	I_S	15	A
Diode pulsed current ²⁾ , $T_C=25^{\circ}\text{C}$	$I_{S, pulse}$	45	A
Power dissipation ³⁾ , $T_C=25^{\circ}\text{C}$	P_D	31	W
Single pulsed avalanche energy ⁴⁾	E_{AS}	200	mJ
MOSFET dv/dt ruggedness, $V_{DS}=0\dots 480\text{ V}$	dv/dt	50	V/ns
Reverse diode dv/dt, $V_{DS}=0\dots 480\text{ V}$, $I_{SD}\leq I_D$	dv/dt	15	V/ns
Operation and storage temperature	T_{stg}, T_j	-55 to 150	$^{\circ}\text{C}$

Thermal Characteristics

Parameter	Symbol	Value	Unit
Thermal resistance, junction-case	$R_{\theta JC}$	4	$^{\circ}\text{C/W}$
Thermal resistance, junction-ambient	$R_{\theta JA}$	62.5	$^{\circ}\text{C/W}$

Electrical Characteristics at $T_j=25^{\circ}\text{C}$ unless otherwise specified

Parameter	Symbol	Min.	Typ.	Max.	Unit	Test condition
Drain-source breakdown voltage	BV_{DSS}	650			V	$V_{GS}=0\text{ V}$, $I_D=250\ \mu\text{A}$
Gate threshold voltage	$V_{GS(th)}$	2.9		3.9	V	$V_{DS}=V_{GS}$, $I_D=250\ \mu\text{A}$
Drain-source on-state resistance	$R_{DS(ON)}$		0.30	0.38	Ω	$V_{GS}=10\text{ V}$, $I_D=5.5\text{ A}$
			0.77			$V_{GS}=10\text{ V}$, $I_D=5.5\text{ A}$, $T_j=150^{\circ}\text{C}$
Gate-source leakage current	I_{GSS}			100	nA	$V_{GS}=30\text{ V}$
				-100		$V_{GS}=-30\text{ V}$
Drain-source leakage current	I_{DSS}			1	μA	$V_{DS}=650\text{ V}$, $V_{GS}=0\text{ V}$

Dynamic Characteristics

Parameter	Symbol	Min.	Typ.	Max.	Unit	Test condition
Input capacitance	C_{iss}		761.3		pF	$V_{GS}=0\text{ V}$, $V_{DS}=50\text{ V}$, $f=1\text{ MHz}$
Output capacitance	C_{oss}		62.0		pF	
Reverse transfer capacitance	C_{rss}		2.5		pF	
Turn-on delay time	$t_{d(on)}$		31.0		ns	$V_{GS}=10\text{ V}$, $V_{DS}=400\text{ V}$, $R_G=2\ \Omega$, $I_D=6\text{ A}$
Rise time	t_r		18.8		ns	
Turn-off delay time	$t_{d(off)}$		58.3		ns	
Fall time	t_f		6.5		ns	

Gate Charge Characteristics

Parameter	Symbol	Min.	Typ.	Max.	Unit	Test condition
Total gate charge	Q_g		15.0		nC	$V_{GS}=10\text{ V}$, $V_{DS}=400\text{ V}$, $I_D=6\text{ A}$
Gate-source charge	Q_{gs}		3.7		nC	
Gate-drain charge	Q_{gd}		5.8		nC	
Gate plateau voltage	$V_{plateau}$		5.7		V	

Body Diode Characteristics

Parameter	Symbol	Min.	Typ.	Max.	Unit	Test condition
Diode forward voltage	V_{SD}			1.3	V	$I_S=11\text{ A}$, $V_{GS}=0\text{ V}$
Reverse recovery time	t_{rr}		239.7		ns	$V_R=400\text{ V}$, $I_S=6\text{ A}$, $di/dt=100\text{ A}/\mu\text{s}$
Reverse recovery charge	Q_{rr}		2.5		μC	
Peak reverse recovery current	I_{rrm}		21.2		A	

Note

- 1) Calculated continuous current based on maximum allowable junction temperature.
- 2) Repetitive rating; pulse width limited by max. junction temperature.
- 3) P_d is based on max. junction temperature, using junction-case thermal resistance.
- 4) $V_{DD}=100\text{ V}$, $V_{GS}=10\text{ V}$, $L=10\text{ mH}$, starting $T_j=25\text{ }^\circ\text{C}$.

Electrical Characteristics Diagrams

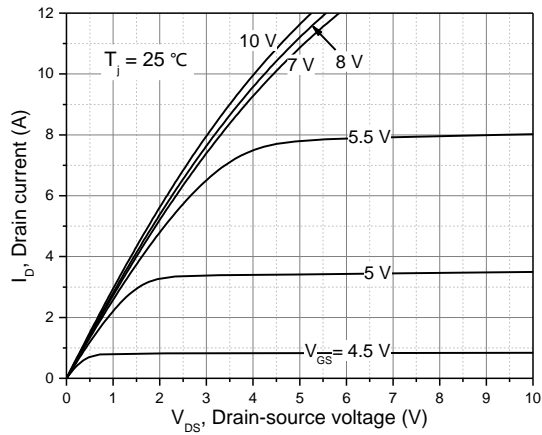

Figure 1. Typ. output characteristics

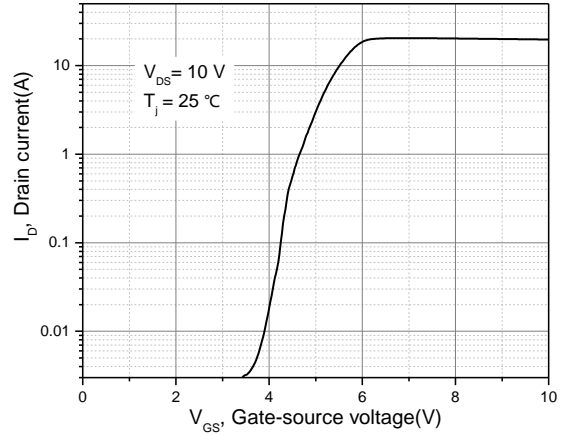

Figure 2. Typ. transfer characteristics

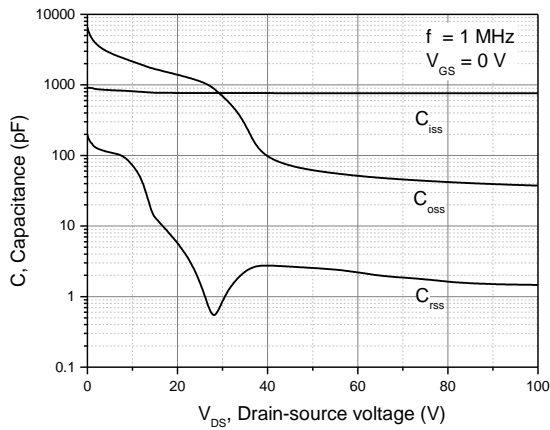

Figure 3. Typ. capacitances

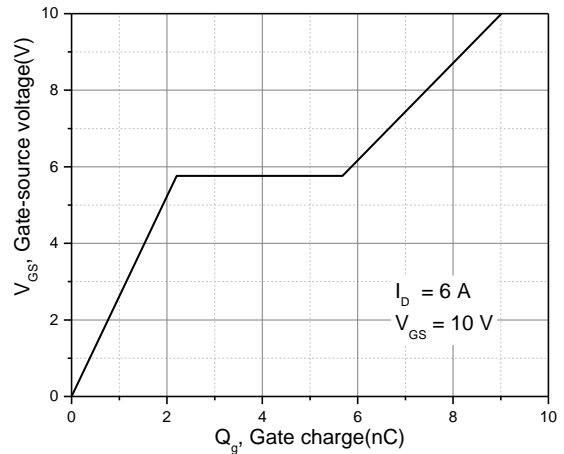

Figure 4. Typ. gate charge

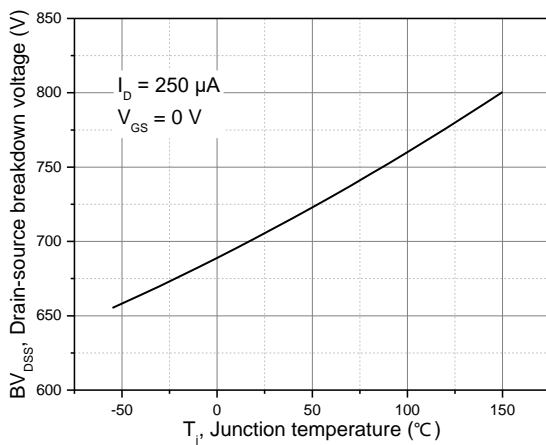

Figure 5. Drain-source breakdown voltage

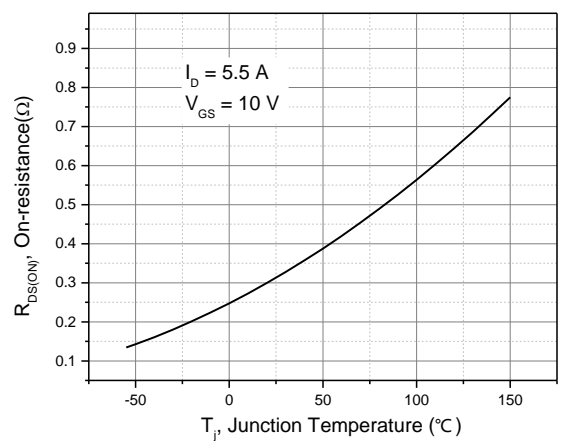
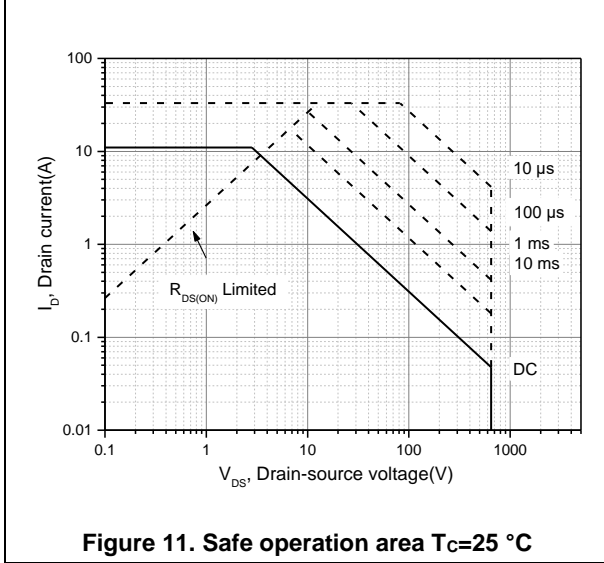
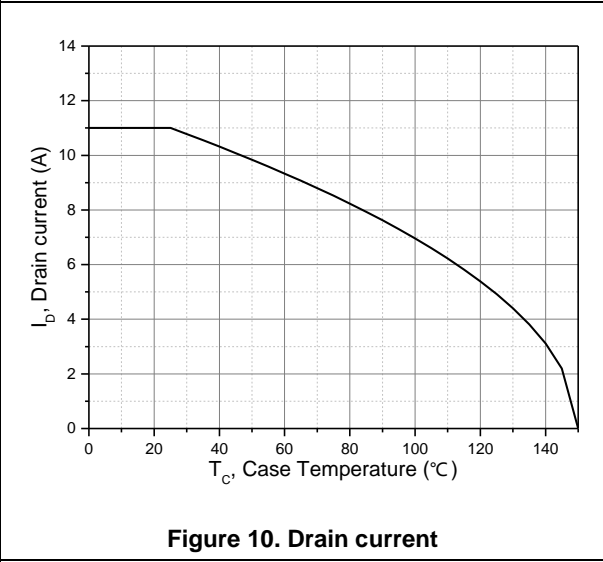
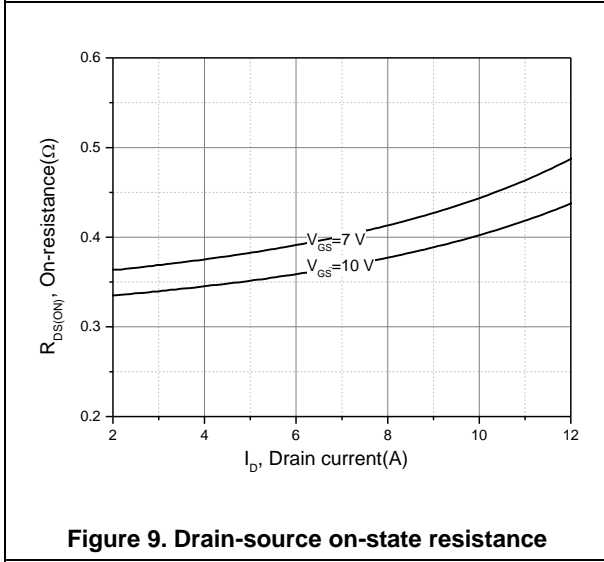
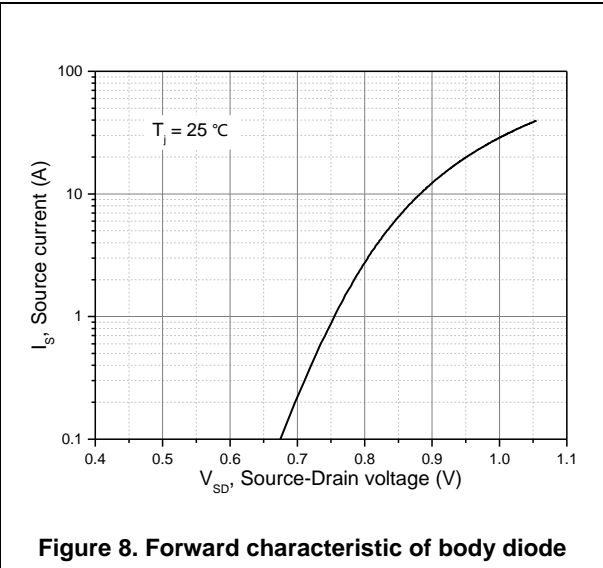
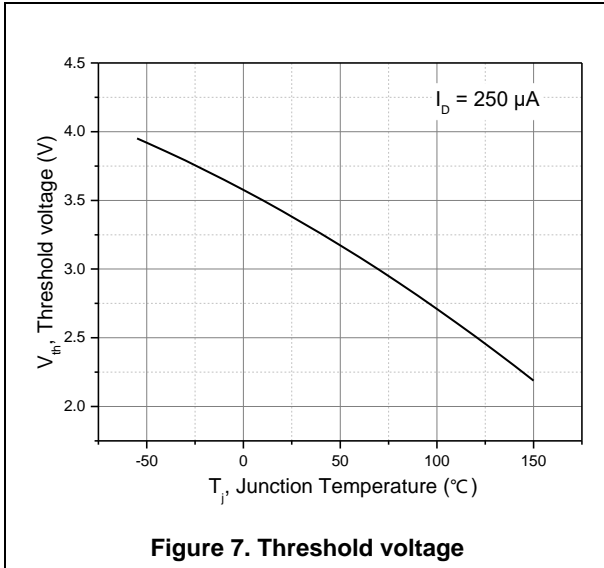

Figure 6. Drain-source on-state resistance



Test circuits and waveforms



Figure 1. Gate charge test circuit & waveform



Figure 2. Switching time test circuit & waveforms

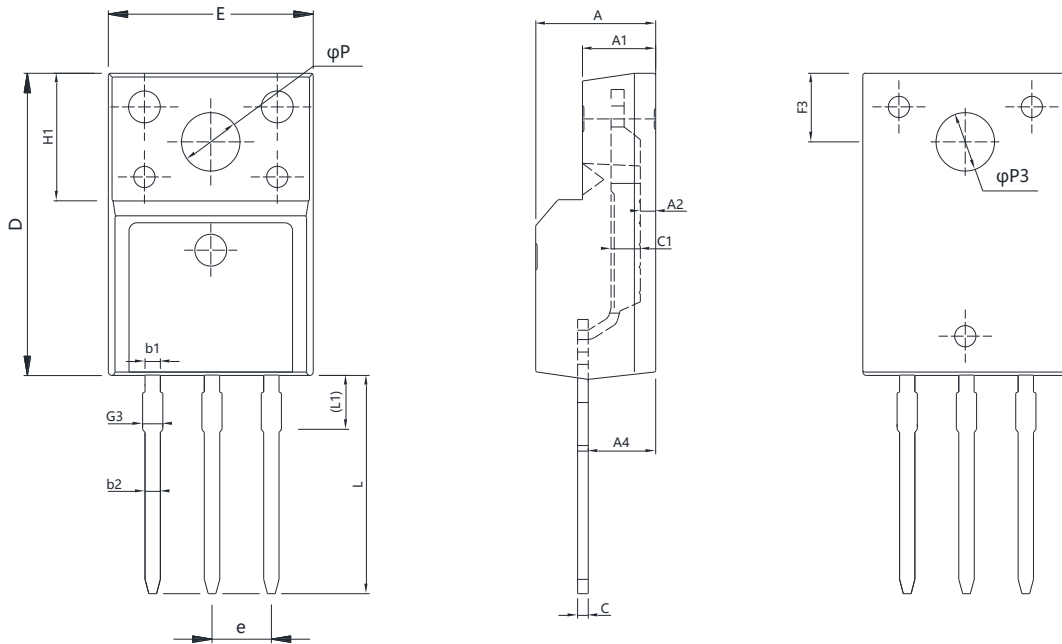

Figure 3. Unclamped inductive switching (UIS) test circuit & waveforms



Figure 4. Diode reverse recovery test circuit & waveforms

Package Information



Symbol	mm		
	Min	Nom	Max
E	9.96	10.16	10.36
A	4.50	4.70	4.90
A1	2.34	2.54	2.74
A2	0.30	0.45	0.60
A4	2.56	2.76	2.96
c	0.40	0.50	0.65
C1	1.20	1.30	1.35
D	15.57	15.87	16.17
H1	6.70REF		
e	2.54BSC		
L	12.68	12.98	13.28
L1	2.88	3.03	3.18
ΦP	3.03	3.18	3.38
ΦP3	3.15	3.45	3.65
F3	3.15	3.30	3.45
G3	1.25	1.35	1.55
b1	1.18	1.28	1.43
b2	0.70	0.80	0.95

Version 1: TO220F-P package outline dimension

Package Information

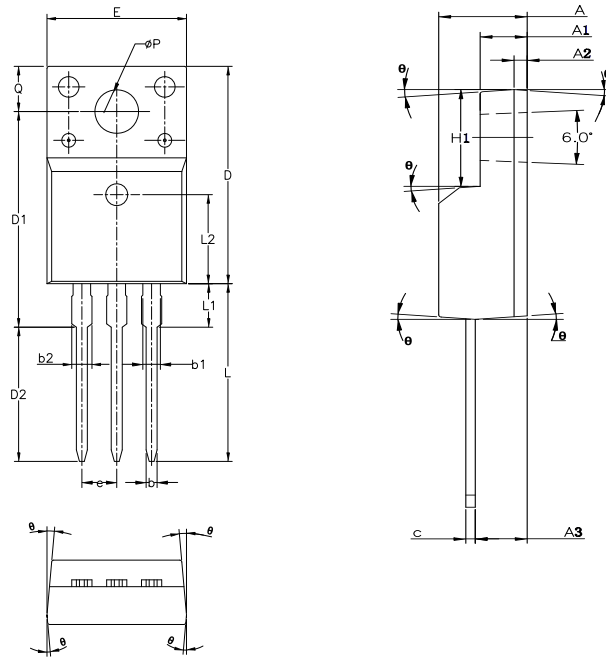

Symbol	mm		
	Min	Nom	Max
A	4.50	4.70	4.83
A1	2.34	2.54	2.74
A2	0.70 REF		
A3	2.56	2.76	2.93
b	0.70	-	0.90
b1	1.18	-	1.38
b2	-	-	1.47
c	0.45	0.50	0.60
D	15.67	15.87	16.07
D1	15.55	15.75	15.95
D2	9.60	9.80	10.00
E	9.96	10.16	10.36
e	2.54 BSC		
H1	6.48	6.68	6.88
L	12.68	12.98	13.28
L1	-	-	3.50
L2	6.50 REF		
ΦP	3.08	3.18	3.28
Q	3.20	-	3.40
θ	1°	3°	5°

Version 2: TO220F-J package outline dimension

Package Information

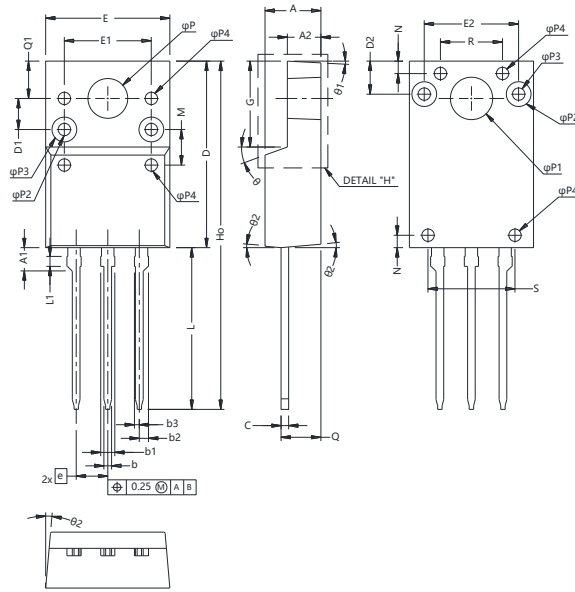

Symbol	mm	
	Min	Max
A	4.30	4.70
A1	1.80	2.10
A2	2.50	2.90
b	0.54	0.84
b1	0.99	1.29
b2	0.56	0.93
b3	0.24	0.55
c	0.49	0.79
D	14.70	15.30
D1	2.50	
D2	2.60	
e	2.29	2.79
E	9.70	10.30
E1	7.00	
E2	7.60	
G	6.70	7.10
H0	28.00	
L	12.50	13.50
L1	0.70	0.90
M	2.86	
N	1.00	
ΦP	3.05	3.40
ΦP1	3.40	
ΦP2	1.00	
ΦP3	2.00	
ΦP4	1.00	
Q	3.10	3.30
Q1	2.70	3.30
R	5.00	
S	7.00	
θ	20°	
θ1	3°	
θ2	5°	

Version 3: TO220F-S package outline dimension

Ordering Information

Package Type	Units/ Tube	Tubes/ Inner Box	Units/ Inner Box	Inner Boxes/ Carton Box	Units/ Carton Box
TO220F-P	50	20	1000	6	6000
TO220F-J	50	20	1000	5	5000
TO220F-S	50	20	1000	6	6000

Product Information

Product	Package	Pb Free	RoHS	Halogen Free
OSG65R380FEF	TO220F	yes	yes	yes

Legal Disclaimer

The information given in this document shall in no event be regarded as a guarantee of conditions or characteristics. With respect to any examples or hints given herein, any typical values stated herein and/or any information regarding the application of the device, Oriental Semiconductor hereby disclaims any and all warranties and liabilities of any kind, including without limitation, warranties of non-infringement of intellectual property rights of any third party.

For further information on technology, delivery terms and conditions and prices, please contact the Oriental Semiconductor sales representatives (www.orientalsemi.com).

© Oriental Semiconductor Co.,Ltd. All Rights Reserved 