

### Features

- 80V/80A,  
 $R_{DS(ON)} = 7m\Omega(Typ.)@V_{GS}=10V$
- Insulation Slug( $V_{ISO} \geq 1500VAC$ )
- Ultra Low On-Resistance
- Exceptional dv/dt capability
- Fast Switching and Fully Avalanche Rated
- 100% avalanche tested
- 175°C Operating Temperature
- Lead Free and Green Devices Available (RoHS Compliant)

### Applications

- Switching Application Systems
- Inverter Systems

### Pin Description

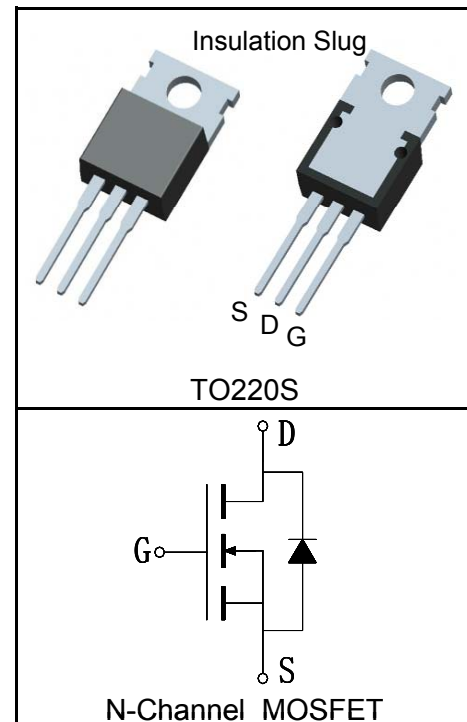

### Absolute Maximum Ratings

Symbol	Parameter	Rating	Unit	
<b>Common Ratings</b> ( $T_C=25^\circ C$ Unless Otherwise Noted)				
$V_{DSS}$	Drain-Source Voltage	80	V	
$V_{GSS}$	Gate-Source Voltage	$\pm 25$		
$T_J$	Maximum Junction Temperature	175	$^\circ C$	
$T_{STG}$	Storage Temperature Range	-55 to 175	$^\circ C$	
$I_S$	Diode Continuous Forward Current	$T_C=25^\circ C$	80	A
<b>Mounted on Large Heat Sink</b>				
$I_{DP}^{①}$	300 $\mu s$ Pulse Drain Current Tested	$T_C=25^\circ C$	320	A
$I_D^{②}$	Continuous Drain Current( $V_{GS}=10V$ )	$T_C=25^\circ C$	80	A
		$T_C=100^\circ C$	56	
$P_D$	Maximum Power Dissipation	$T_C=25^\circ C$	150	W
		$T_C=100^\circ C$	75	
$R_{\theta JC}$	Thermal Resistance-Junction to Case	1.0	$^\circ C/W$	
$R_{\theta JA}$	Thermal Resistance-Junction to Ambient	62.5	$^\circ C/W$	
<b>Drain-Source Avalanche Ratings</b>				
$E_{AS}^{③}$	Avalanche Energy, Single Pulsed	225	mJ	

**Electrical Characteristics** ( $T_C=25^{\circ}\text{C}$  Unless Otherwise Noted)

Symbol	Parameter	Test Condition	RU7588R3			Unit
			Min.	Typ.	Max.	
<b>Static Characteristics</b>						
$BV_{DSS}$	Drain-Source Breakdown Voltage	$V_{GS}=0V, I_{DS}=250\mu A$	80			V
$I_{DSS}$	Zero Gate Voltage Drain Current	$V_{DS}=80V, V_{GS}=0V$			1	$\mu A$
		$T_J=125^{\circ}\text{C}$			30	
$V_{GS(th)}$	Gate Threshold Voltage	$V_{DS}=V_{GS}, I_{DS}=250\mu A$	2	3	4	V
$I_{GSS}$	Gate Leakage Current	$V_{GS}=\pm 25V, V_{DS}=0V$			$\pm 100$	nA
$R_{DS(ON)}^{(4)}$	Drain-Source On-state Resistance	$V_{GS}=10V, I_{DS}=40A$		7	9	m $\Omega$
<b>Diode Characteristics</b>						
$V_{SD}^{(4)}$	Diode Forward Voltage	$I_{SD}=40A, V_{GS}=0V$			1.2	V
$t_{rr}$	Reverse Recovery Time	$I_{SD}=40A, di_{SD}/dt=100A/\mu s$		48		ns
$Q_{rr}$	Reverse Recovery Charge			105		nC
<b>Dynamic Characteristics</b> <sup>(5)</sup>						
$R_G$	Gate Resistance	$V_{GS}=0V, V_{DS}=0V, F=1\text{MHz}$		1.4		$\Omega$
$C_{iss}$	Input Capacitance	$V_{GS}=0V,$ $V_{DS}=30V,$ Frequency=1.0MHz		3400		pF
$C_{oss}$	Output Capacitance			450		
$C_{riss}$	Reverse Transfer Capacitance			170		
$t_{d(ON)}$	Turn-on Delay Time	$V_{DD}=30V, I_{DS}=40A,$ $V_{GEN}=10V, R_G=7\Omega$		14		ns
$t_r$	Turn-on Rise Time			16		
$t_{d(OFF)}$	Turn-off Delay Time			31		
$t_f$	Turn-off Fall Time			54		
<b>Gate Charge Characteristics</b> <sup>(5)</sup>						
$Q_g$	Total Gate Charge	$V_{DS}=60V, V_{GS}=10V,$ $I_{DS}=40A$		64		nC
$Q_{gs}$	Gate-Source Charge			13		
$Q_{gd}$	Gate-Drain Charge			22		

- Notes:
- ① Pulse width limited by safe operating area.
  - ② Calculated continuous current based on maximum allowable junction temperature. The package limitation current is 75A.
  - ③ Limited by  $T_{Jmax}$ ,  $I_{AS}=30A$ ,  $V_{DD}=48V$ ,  $R_G=50\Omega$ , Starting  $T_J=25^{\circ}\text{C}$ .
  - ④ Pulse test; Pulse width  $\leq 300\mu s$ , duty cycle  $\leq 2\%$ .
  - ⑤ Guaranteed by design, not subject to production testing.

**Ordering and Marking Information**

<b>Device</b>	<b>Marking</b>	<b>Package</b>	<b>Packaging</b>	<b>Quantity</b>	<b>Reel Size</b>	<b>Tape width</b>
RU7588R3	RU7588R3	TO220S	Tube	50	-	-

**Typical Characteristics**

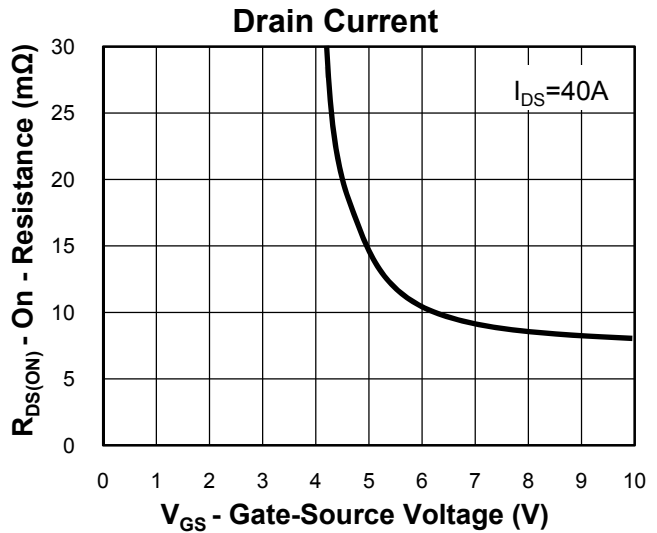
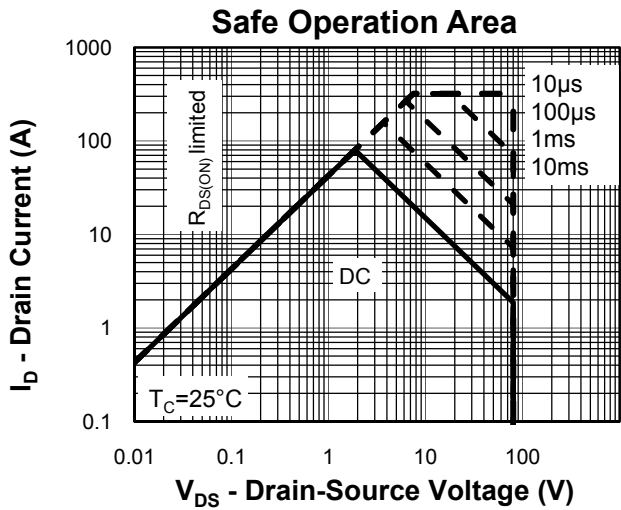
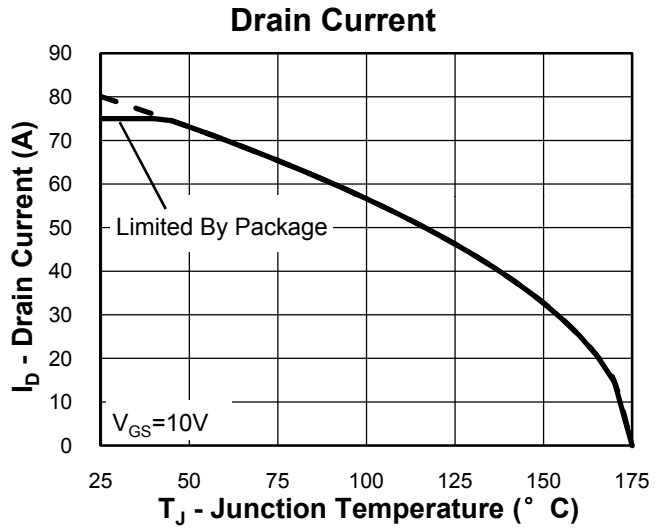
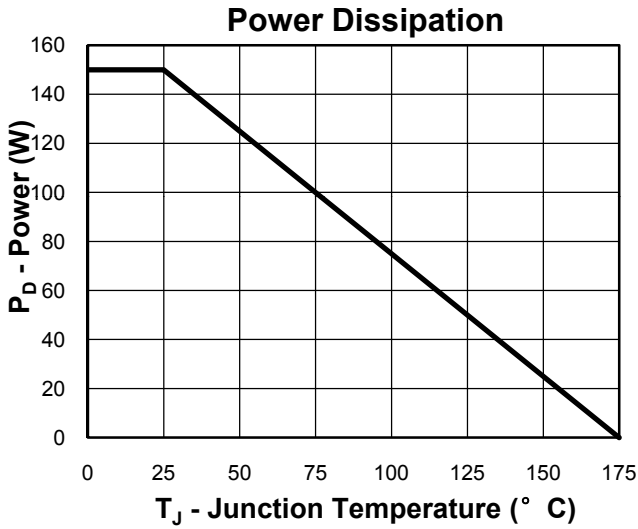

**Thermal Transient Impedance**

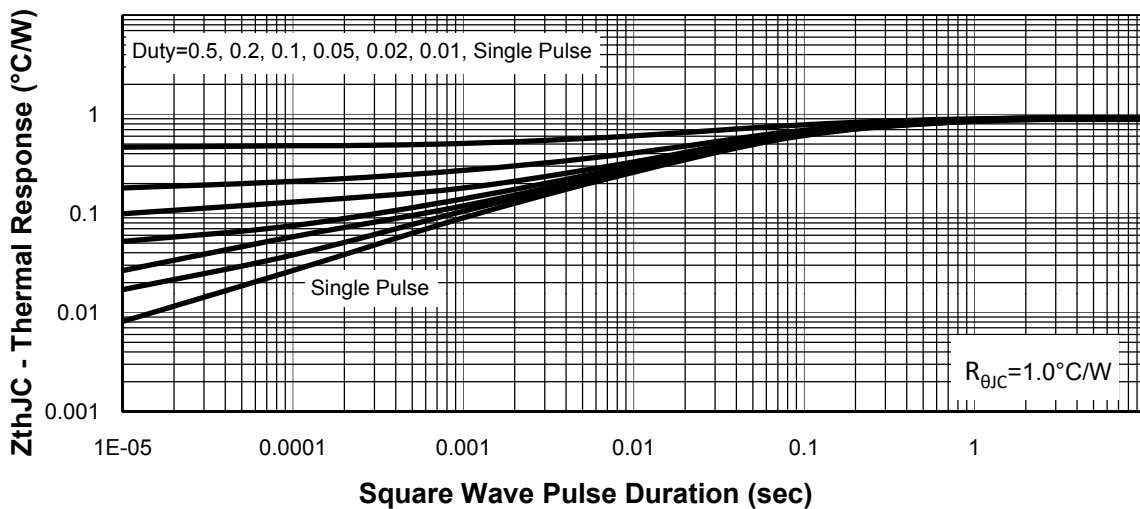

**Typical Characteristics**

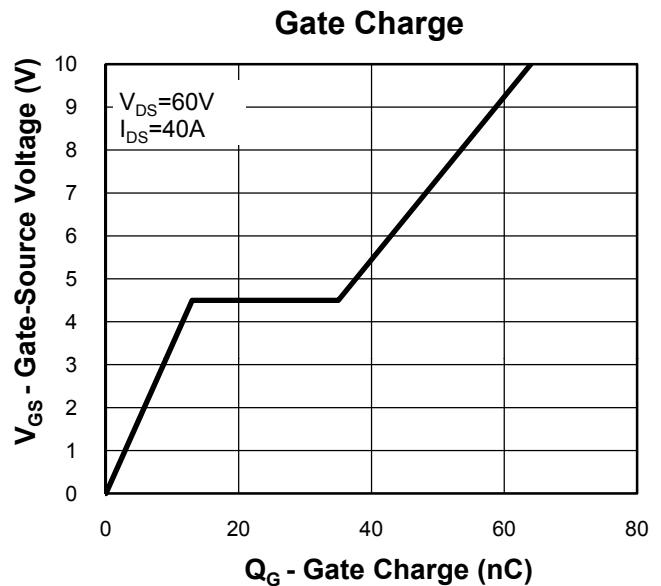
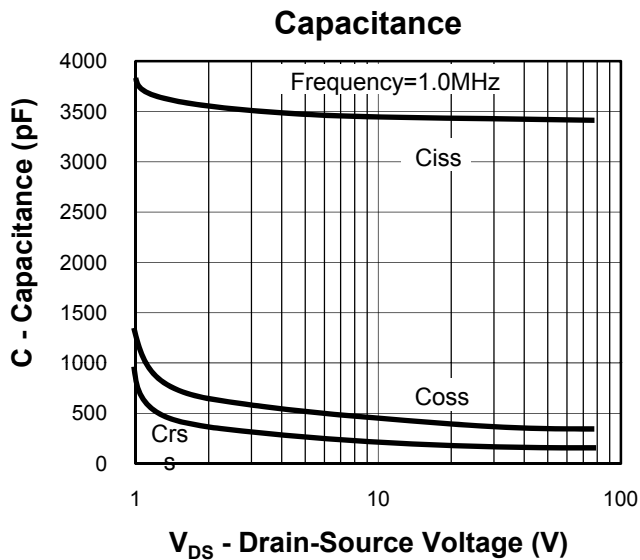
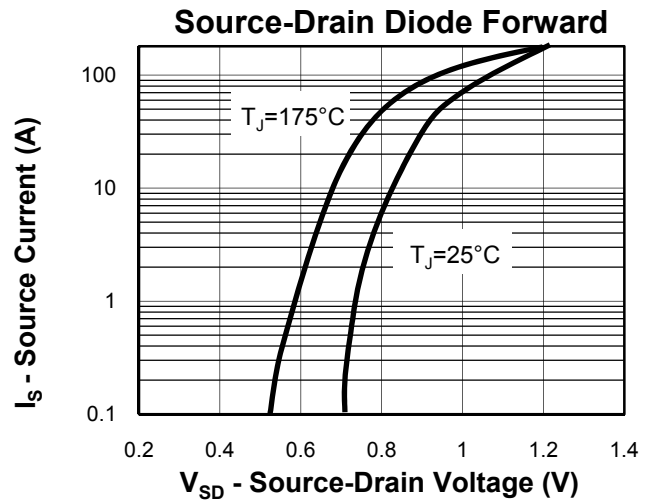
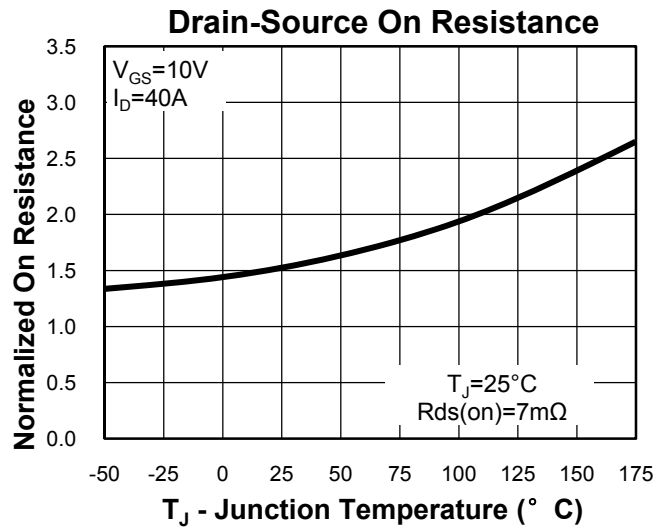
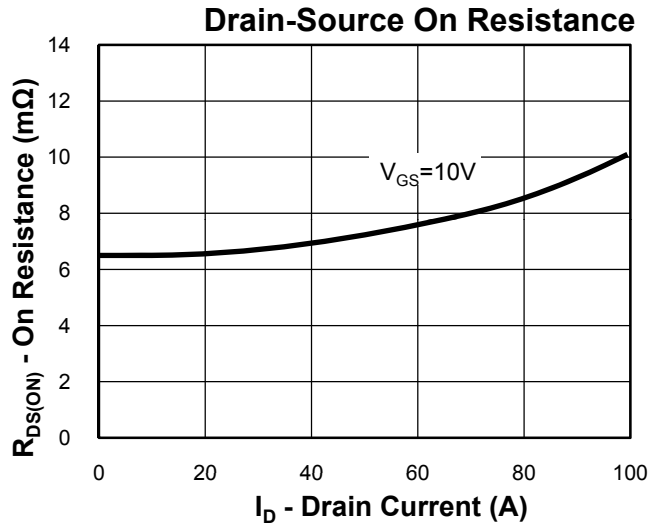
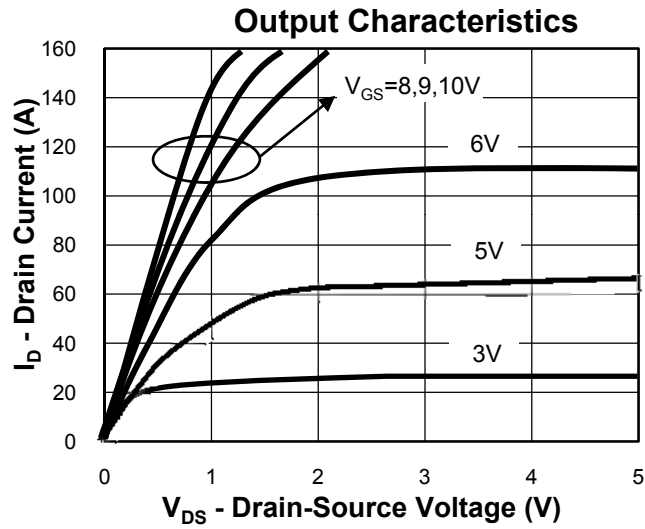

**Avalanche Test Circuit and Waveforms**

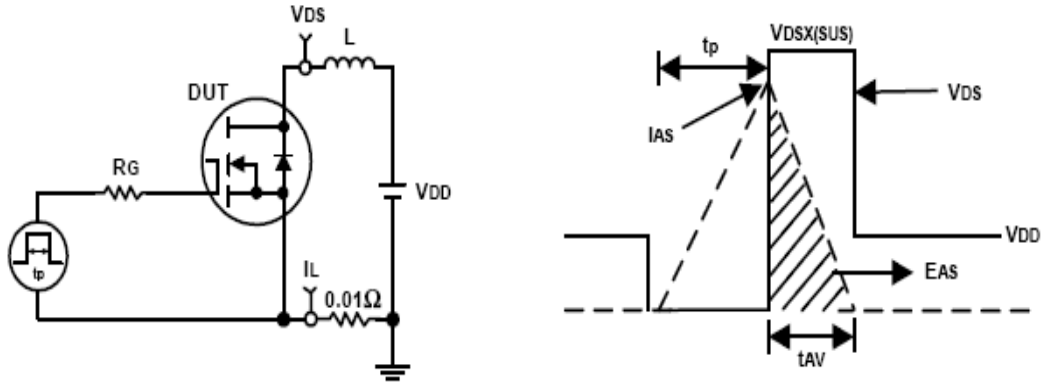

**Switching Time Test Circuit and Waveforms**

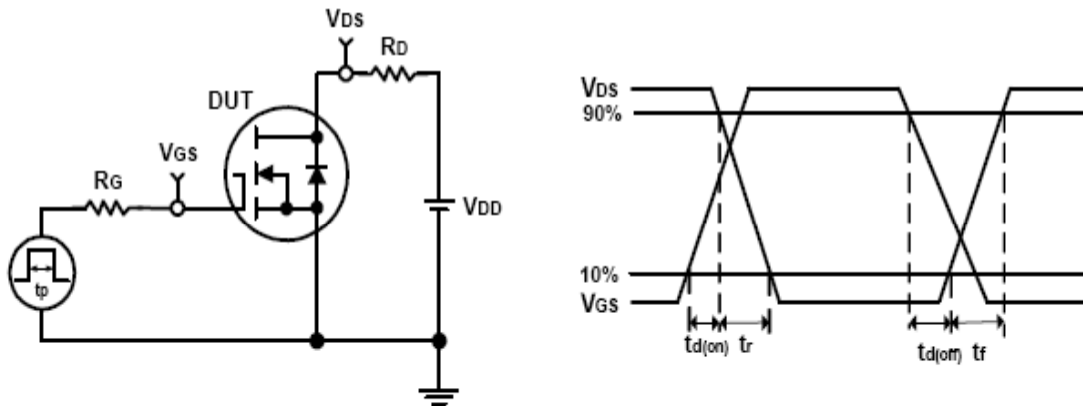

**Package Information**

**TO220S**

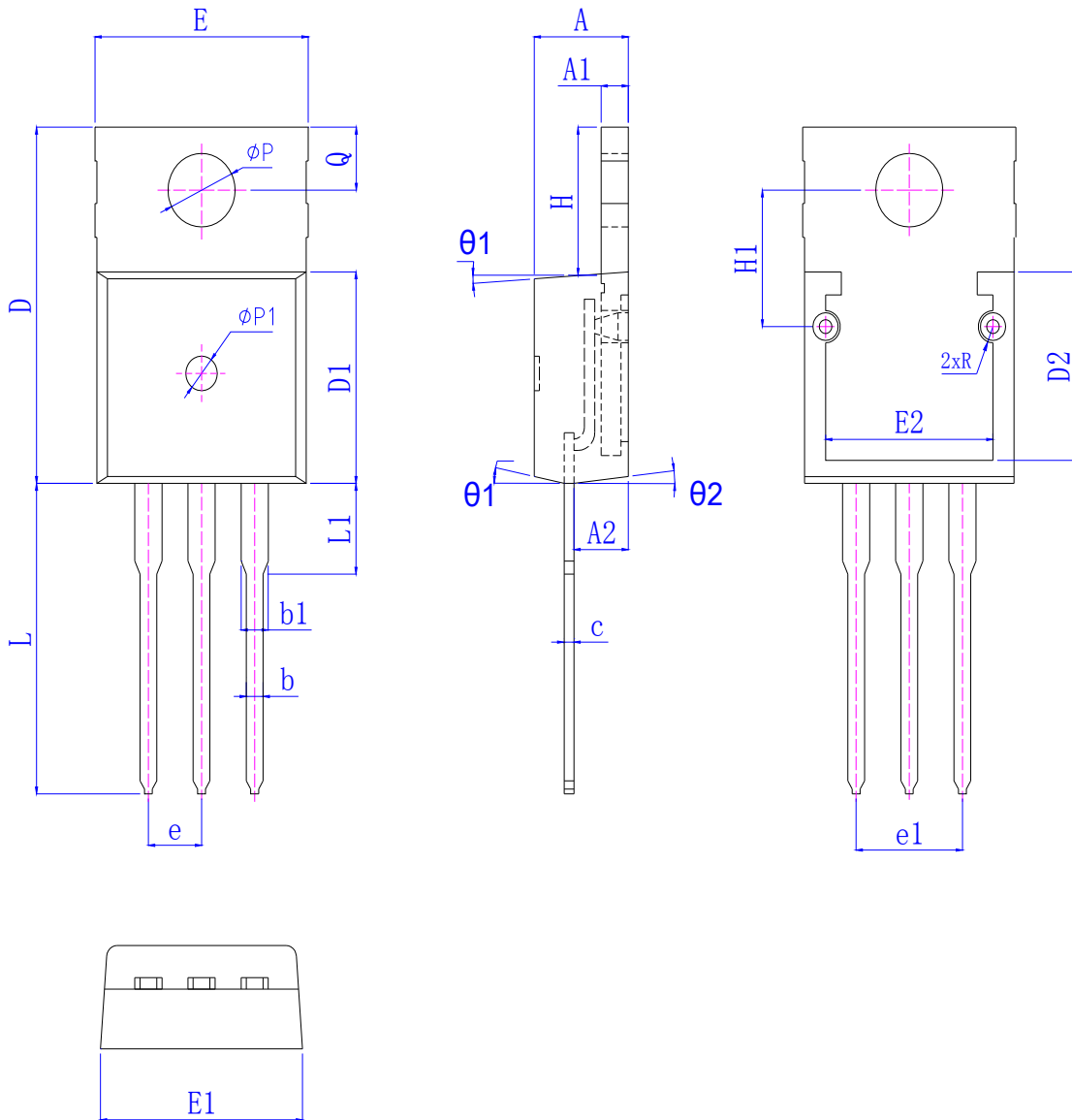

SYMBOL	MM			INCH			SYMBOL	MM			INCH		
	MIN	NOM	MAX	MIN	NOM	MAX		MIN	NOM	MAX	MIN	NOM	MAX
A	4.30	4.50	4.70	0.169	0.177	0.185	$\Phi p$	3.20	*	3.30	0.126	*	0.130
A1	1.25	1.27	1.29	0.049	0.050	0.051	e	2.54 BSC			0.10 BSC		
A2	2.37	2.57	2.77	0.093	0.101	0.109	e1	5.08 BSC			0.20 BSC		
b	0.60	0.80	1.00	0.024	0.031	0.039	H	6.13	6.23	6.43	0.241	0.245	0.253
b1	1.24	1.34	1.44	0.049	0.053	0.057	H1	5.89	5.94	5.99	0.232	0.234	0.236
c	0.40	0.50	0.60	0.016	0.020	0.024	L	12.90	13.40	13.90	0.508	0.528	0.547
D	15.33	15.53	15.73	0.604	0.611	0.619	L1	*	*	3.92	*	*	0.154
D1	9.10	9.30	9.50	0.358	0.366	0.374	$\Phi p1$	1.40	1.50	1.60	0.055	0.059	0.063
D2	8.14	8.19	8.24	0.320	0.322	0.324	Q	*	2.74	*	*	0.108	*
E	10.10	10.20	10.30	0.398	0.402	0.406	R	0.675	0.700	0.725	0.027	0.028	0.029
E1	9.96	10.16	10.36	0.392	0.400	0.408	$\theta 1$	1°	3°	5°	1°	3°	5°
E2	8.13	8.18	8.23	0.320	0.322	0.324	$\theta 2$	1°	3°	5°	1°	3°	5°

**Customer Service**

**Worldwide Sales and Service:**  
Sales@ruichips.com

**Technical Support:**  
Technical@ruichips.com

**Investor Relations Contacts:**  
Investor@ruichips.com

**Marcom Contact:**  
Marcom@ruichips.com

**Editorial Contact:**  
Editorial@ruichips.com

**HR Contact:**  
HR@ruichips.com

**Legal Contact:**  
Legal@ruichips.com

**Shen Zhen RUICHIPS Semiconductor CO., LTD**  
4th Floor, Block 8, Changyuan New Material Port, Keyuan Middle Road, Science & Industry Park,  
Nanshan District, Shenzhen, CHINA

**TEL:** (86-755) 8311-5334  
**FAX:** (86-755) 8311-4278  
**E-mail:** Sales-SZ@ruichips.com