

Cool MOS™ Power Transistor

Feature

- New revolutionary high voltage technology
- Ultra low gate charge
- Periodic avalanche rated
- Extreme dv/dt rated
- Ultra low effective capacitances
- Improved transconductance
- PG-TO-220-3-31: Fully isolated package (2500 VAC; 1 minute)
- Pb-free lead plating; RoHS compliant
- Qualified according to JEDEC⁰⁾ for target applications

V_{DS}	800	V
$R_{DS(on)}$	0.9	Ω
I_D	6	A

PG-TO220-3-31 PG-TO220

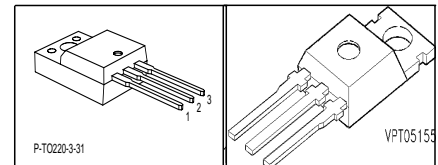

Type	Package	Ordering Code	Marking
SPP06N80C3	PG-TO220	Q67040-S4351	06N80C3
SPA06N80C3	PG-TO220-3-31	SP000216302	06N80C3

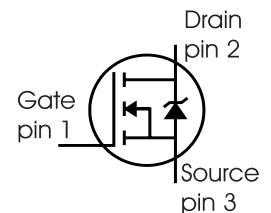

Maximum Ratings

Parameter	Symbol	Value		Unit
		SPP	SPA	
Continuous drain current $T_C = 25\text{ }^\circ\text{C}$ $T_C = 100\text{ }^\circ\text{C}$	I_D	6 3.8	6 ¹⁾ 3.8 ¹⁾	A
Pulsed drain current, t_p limited by T_{jmax}	$I_{D\text{ puls}}$	18	18	A
Avalanche energy, single pulse $I_D=1.2\text{A}$, $V_{DD}=50\text{V}$	E_{AS}	230	230	mJ
Avalanche energy, repetitive t_{AR} limited by T_{jmax} ²⁾ $I_D=6\text{A}$, $V_{DD}=50\text{V}$	E_{AR}	0.2	0.2	
Avalanche current, repetitive t_{AR} limited by T_{jmax}	I_{AR}	6	6	A
Gate source voltage	V_{GS}	± 20	± 20	V
Gate source voltage AC ($f > 1\text{Hz}$)	V_{GS}	± 30	± 30	
Power dissipation, $T_C = 25\text{ }^\circ\text{C}$	P_{tot}	83	39	W
Operating and storage temperature	T_j, T_{stg}	-55...+150		$^\circ\text{C}$

Maximum Ratings

Parameter	Symbol	Value	Unit
Drain Source voltage slope $V_{DS} = 640 \text{ V}$, $I_D = 6 \text{ A}$, $T_j = 125 \text{ }^\circ\text{C}$	dv/dt	50	V/ns

Thermal Characteristics

Parameter	Symbol	Values			Unit
		min.	typ.	max.	
Thermal resistance, junction - case	R_{thJC}	-	-	1.5	K/W
Thermal resistance, junction - case, FullPAK	$R_{thJC \text{ FP}}$	-	-	3.9	
Thermal resistance, junction - ambient, leaded	R_{thJA}	-	-	62	
Thermal resistance, junction - ambient, FullPAK	$R_{thJA \text{ FP}}$	-	-	80	
Soldering temperature, wavesoldering 1.6 mm (0.063 in.) from case for 10s ³)	T_{sold}	-	-	260	$^\circ\text{C}$

Electrical Characteristics, at $T_j=25^\circ\text{C}$ unless otherwise specified

Parameter	Symbol	Conditions	Values			Unit
			min.	typ.	max.	
Drain-source breakdown voltage	$V_{(BR)DSS}$	$V_{GS}=0\text{V}$, $I_D=0.25\text{mA}$	800	-	-	V
Drain-Source avalanche breakdown voltage	$V_{(BR)DS}$	$V_{GS}=0\text{V}$, $I_D=6\text{A}$	-	870	-	
Gate threshold voltage	$V_{GS(th)}$	$I_D=250\mu\text{A}$, $V_{GS}=V_{DS}$	2.1	3	3.9	
Zero gate voltage drain current	I_{DSS}	$V_{DS}=800\text{V}$, $V_{GS}=0\text{V}$, $T_j=25^\circ\text{C}$ $T_j=150^\circ\text{C}$	-	0.5	10	μA
			-	-	100	
Gate-source leakage current	I_{GSS}	$V_{GS}=20\text{V}$, $V_{DS}=0\text{V}$	-	-	100	nA
Drain-source on-state resistance	$R_{DS(on)}$	$V_{GS}=10\text{V}$, $I_D=3.8\text{A}$ $T_j=25^\circ\text{C}$ $T_j=150^\circ\text{C}$	-	0.78	0.9	Ω
			-	2.1	-	
Gate input resistance	R_G	$f=1\text{MHz}$, open drain	-	0.7	-	

Electrical Characteristics

Parameter	Symbol	Conditions	Values			Unit
			min.	typ.	max.	
Transconductance	g_{fs}	$V_{DS} \geq 2 \cdot I_D \cdot R_{DS(on)max}$, $I_D = 3.8A$	-	4	-	S
Input capacitance	C_{iss}	$V_{GS} = 0V$, $V_{DS} = 25V$, $f = 1MHz$	-	785	-	pF
Output capacitance	C_{oss}		-	390	-	
Reverse transfer capacitance	C_{rss}		-	20	-	
Effective output capacitance, ⁴⁾ energy related	$C_{o(er)}$	$V_{GS} = 0V$, $V_{DS} = 0V$ to 480V	-	22	-	
Effective output capacitance, ⁵⁾ time related	$C_{o(tr)}$		-	42	-	
Turn-on delay time	$t_{d(on)}$	$V_{DD} = 400V$, $V_{GS} = 0/10V$, $I_D = 6A$, $R_G = 15\Omega$, $T_j = 125^\circ C$	-	25	-	ns
Rise time	t_r		-	15	-	
Turn-off delay time	$t_{d(off)}$		-	65	75	
Fall time	t_f		-	8	11	

Gate Charge Characteristics

Gate to source charge	Q_{gs}	$V_{DD} = 640V$, $I_D = 6A$	-	3.3	-	nC
Gate to drain charge	Q_{gd}		-	14	-	
Gate charge total	Q_g	$V_{DD} = 640V$, $I_D = 6A$, $V_{GS} = 0$ to 10V	-	27	35	
Gate plateau voltage	$V_{(plateau)}$	$V_{DD} = 640V$, $I_D = 6A$	-	6	-	V

⁰J-STD20 and JESD22

¹Limited only by maximum temperature

²Repetitive avalanche causes additional power losses that can be calculated as $P_{AV} = E_{AR} \cdot f$.

³Soldering temperature for TO-263: 220°C, reflow

⁴ $C_{o(er)}$ is a fixed capacitance that gives the same stored energy as C_{oss} while V_{DS} is rising from 0 to 80% V_{DSS} .

⁵ $C_{o(tr)}$ is a fixed capacitance that gives the same charging time as C_{oss} while V_{DS} is rising from 0 to 80% V_{DSS} .

Electrical Characteristics

Parameter	Symbol	Conditions	Values			Unit
			min.	typ.	max.	
Inverse diode continuous forward current	I_S	$T_C=25^\circ\text{C}$	-	-	6	A
Inverse diode direct current, pulsed	I_{SM}		-	-	18	
Inverse diode forward voltage	V_{SD}	$V_{GS}=0\text{V}, I_F=I_S$	-	1	1.2	V
Reverse recovery time	t_{rr}	$V_R=400\text{V}, I_F=I_S,$	-	520	-	ns
Reverse recovery charge	Q_{rr}	$di_F/dt=100\text{A}/\mu\text{s}$	-	5	-	μC
Peak reverse recovery current	I_{rrm}		-	18	-	A
Peak rate of fall of reverse recovery current	di_{rr}/dt	$T_j=25^\circ\text{C}$	-	400	-	$\text{A}/\mu\text{s}$

Typical Transient Thermal Characteristics

Symbol	Value		Unit	Symbol	Value		Unit
	SPP	SPA			SPP	SPA	
R_{th1}	0.024	0.024	K/W	C_{th1}	0.0001172	0.0001172	Ws/K
R_{th2}	0.048	0.048		C_{th2}	0.000447	0.000447	
R_{th3}	0.083	0.086		C_{th3}	0.0006303	0.0006303	
R_{th4}	0.309	0.195		C_{th4}	0.001828	0.001828	
R_{th5}	0.317	0.451		C_{th5}	0.004786	0.007578	
R_{th6}	0.112	2.51		C_{th6}	0.046	0.412	

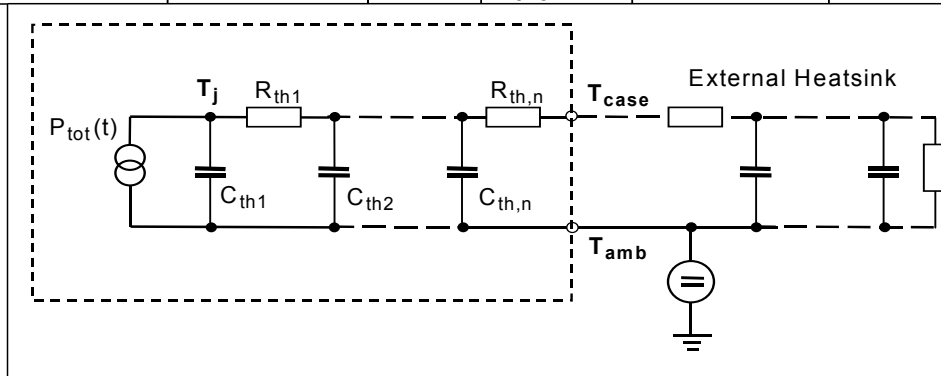

1 Power dissipation

$P_{tot} = f(T_C)$

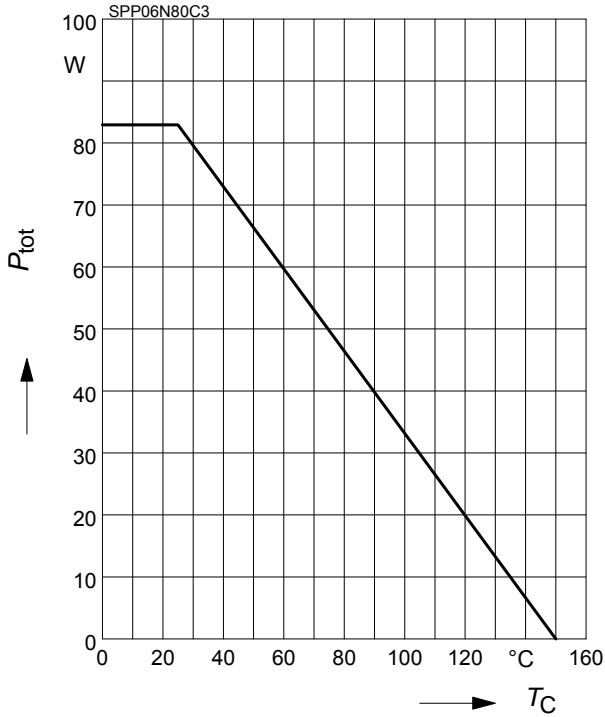

2 Power dissipation FullPAK

$P_{tot} = f(T_C)$

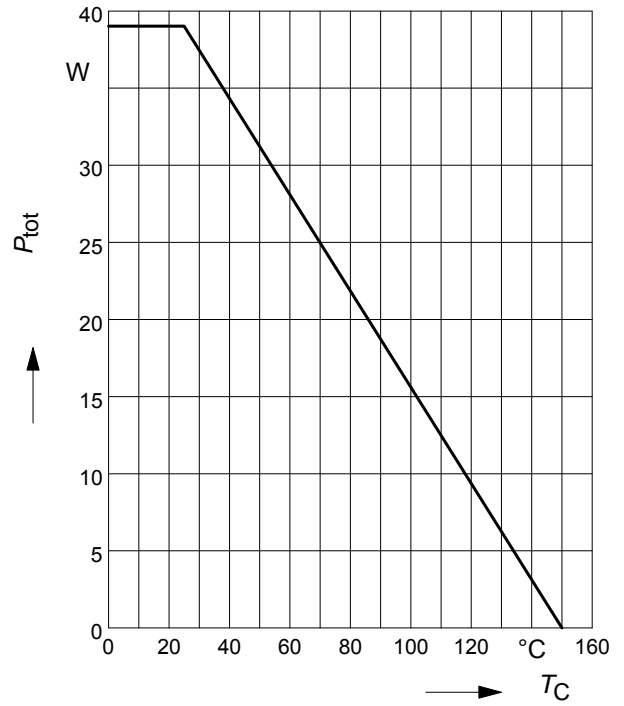

3 Safe operating area

$I_D = f(V_{DS})$

parameter : $D = 0$, $T_C = 25^\circ\text{C}$

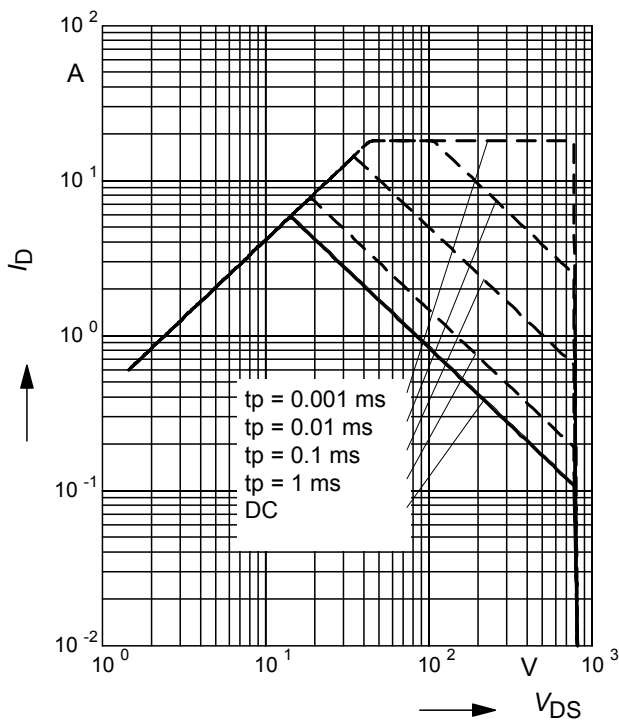

4 Safe operating area FullPAK

$I_D = f(V_{DS})$

parameter: $D = 0$, $T_C = 25^\circ\text{C}$

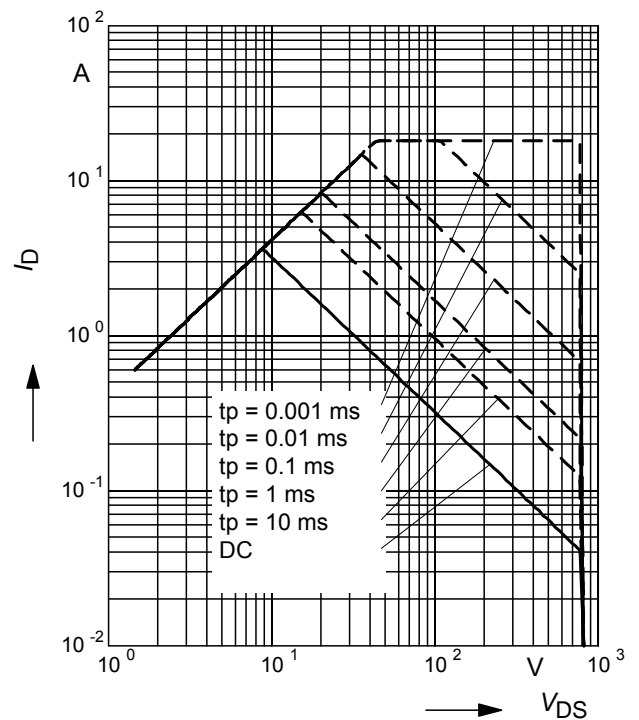

5 Transient thermal impedance

$$Z_{thJC} = f(t_p)$$

parameter: $D = t_p/T$

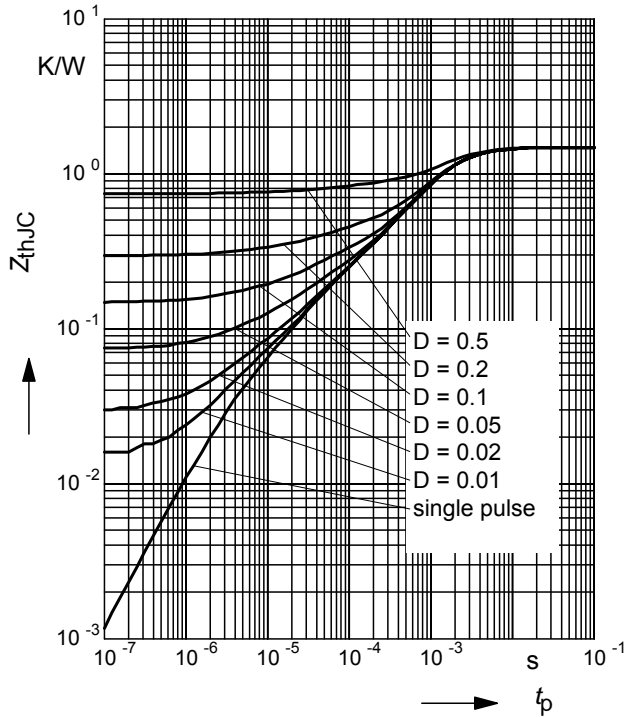

6 Transient thermal impedance FullPAK

$$Z_{thJC} = f(t_p)$$

parameter: $D = t_p/t$

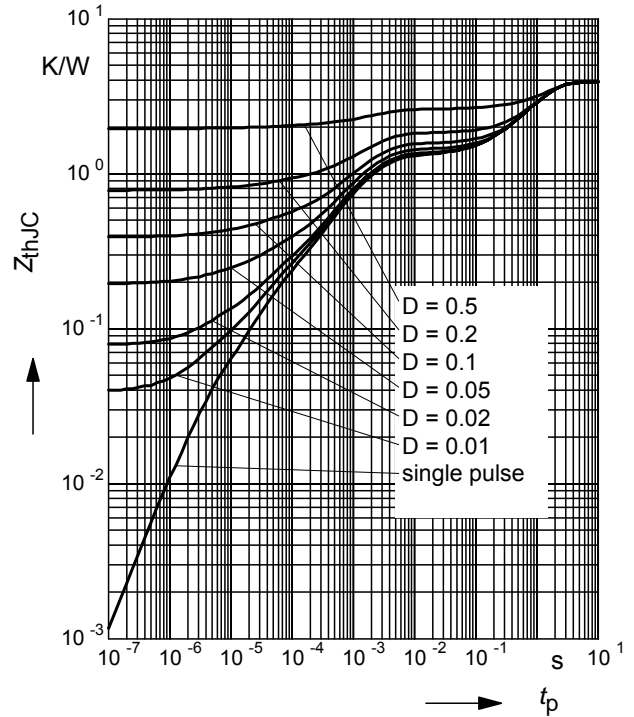

7 Typ. output characteristic

$$I_D = f(V_{DS}); T_j = 25^\circ\text{C}$$

parameter: $t_p = 10 \mu\text{s}, V_{GS}$

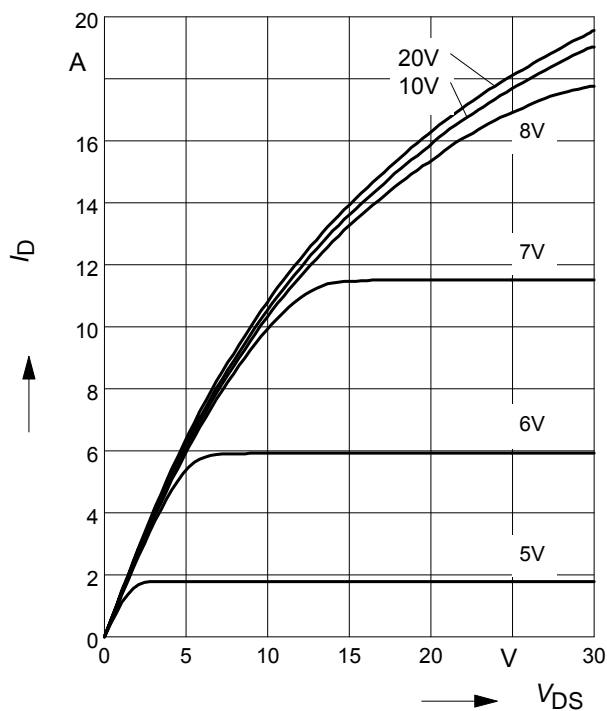

8 Typ. output characteristic

$$I_D = f(V_{DS}); T_j = 150^\circ\text{C}$$

parameter: $t_p = 10 \mu\text{s}, V_{GS}$

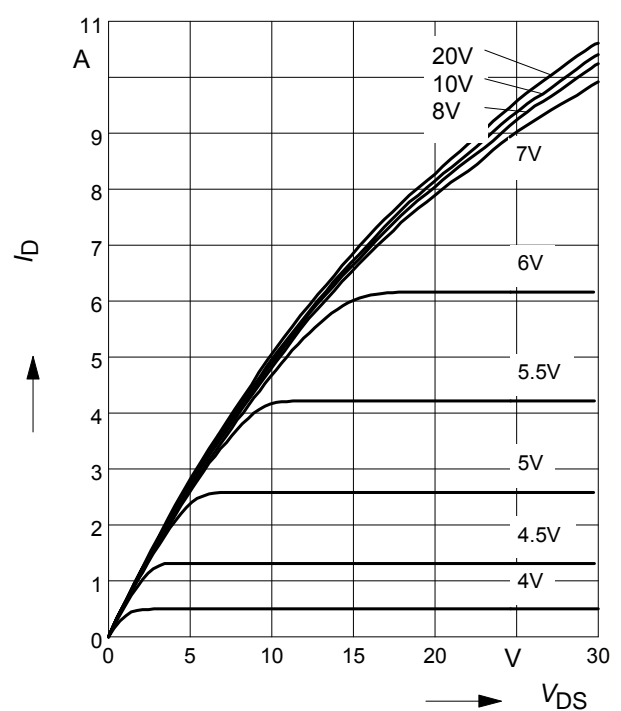

9 Typ. drain-source on resistance

$$R_{DS(on)} = f(I_D)$$

parameter: $T_j = 150^\circ\text{C}$, V_{GS}

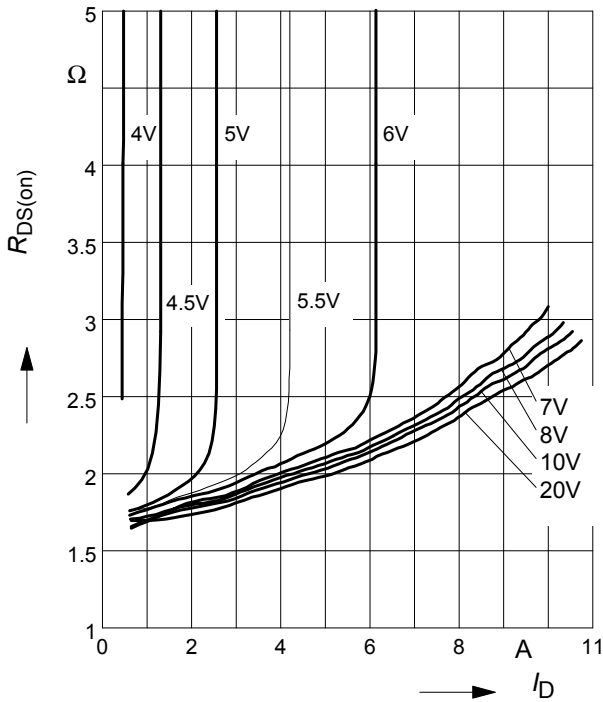

10 Drain-source on-state resistance

$$R_{DS(on)} = f(T_j)$$

parameter: $I_D = 3.8\text{ A}$, $V_{GS} = 10\text{ V}$

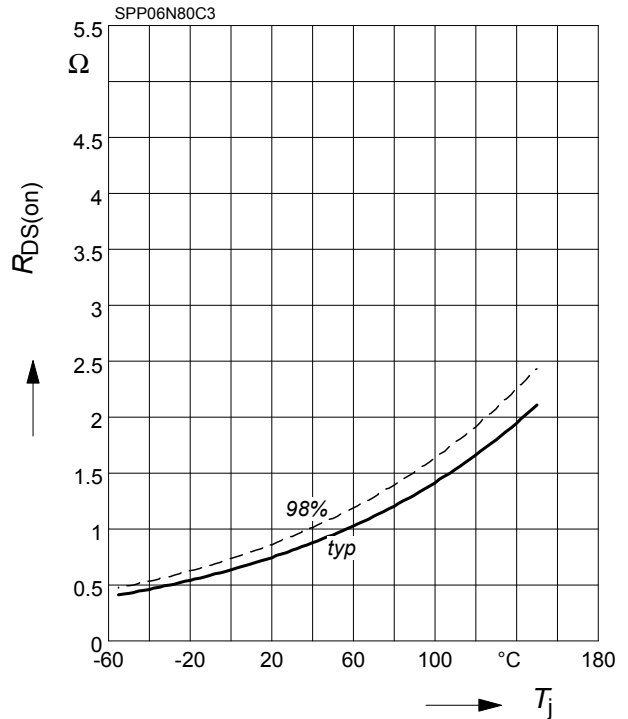

11 Typ. transfer characteristics

$$I_D = f(V_{GS}); V_{DS} \geq 2 \times I_D \times R_{DS(on)max}$$

parameter: $t_p = 10\ \mu\text{s}$

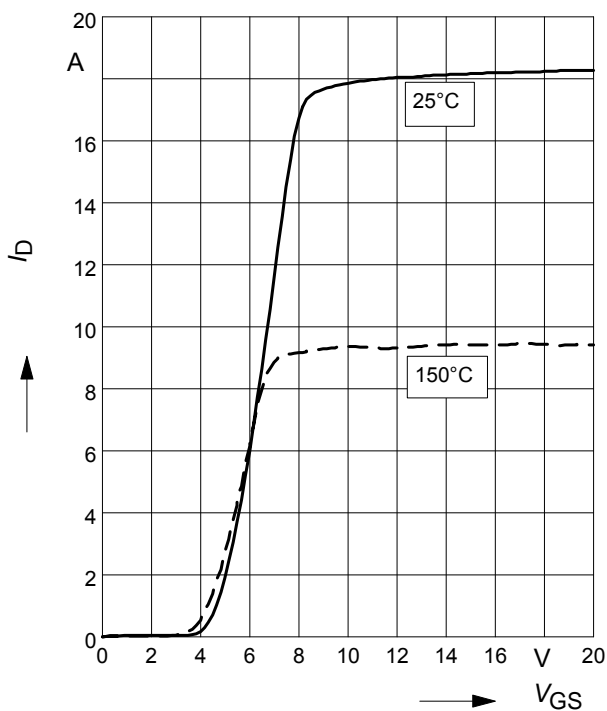

12 Typ. gate charge

$$V_{GS} = f(Q_{Gate})$$

parameter: $I_D = 6\text{ A pulsed}$

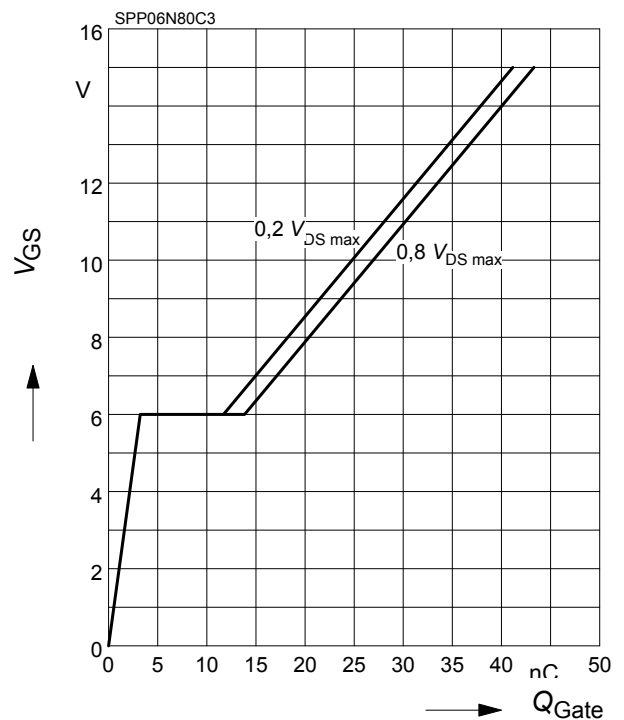

13 Forward characteristics of body diode

$$I_F = f(V_{SD})$$

parameter: T_j , $t_p = 10 \mu s$

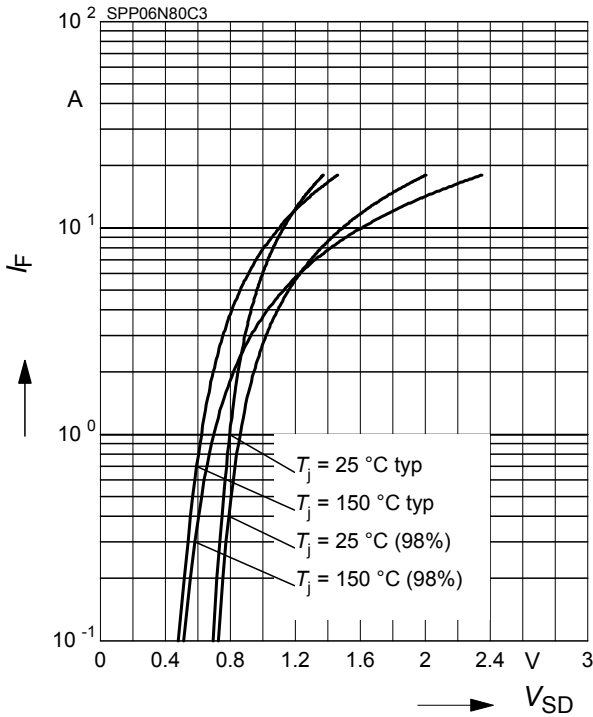

14 Avalanche SOA

$$I_{AR} = f(t_{AR})$$

par.: $T_j \leq 150 \text{ °C}$

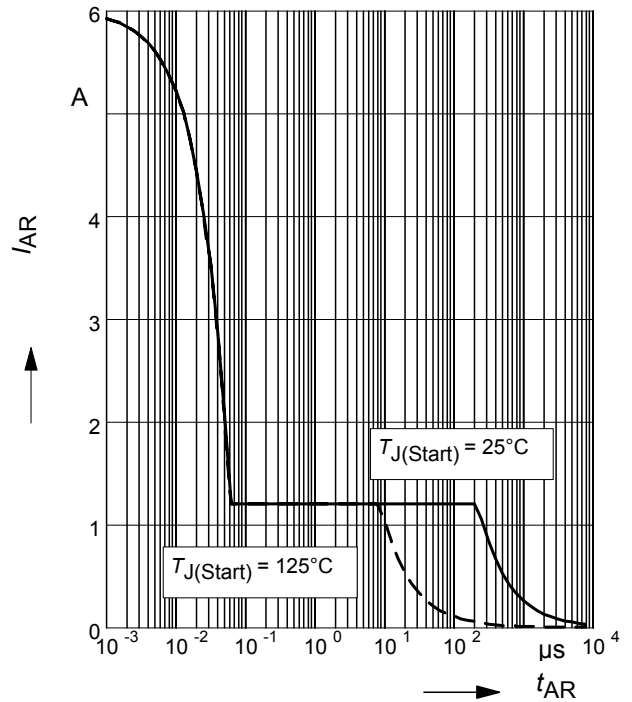

15 Avalanche energy

$$E_{AS} = f(T_j)$$

par.: $I_D = 1.2 \text{ A}$, $V_{DD} = 50 \text{ V}$

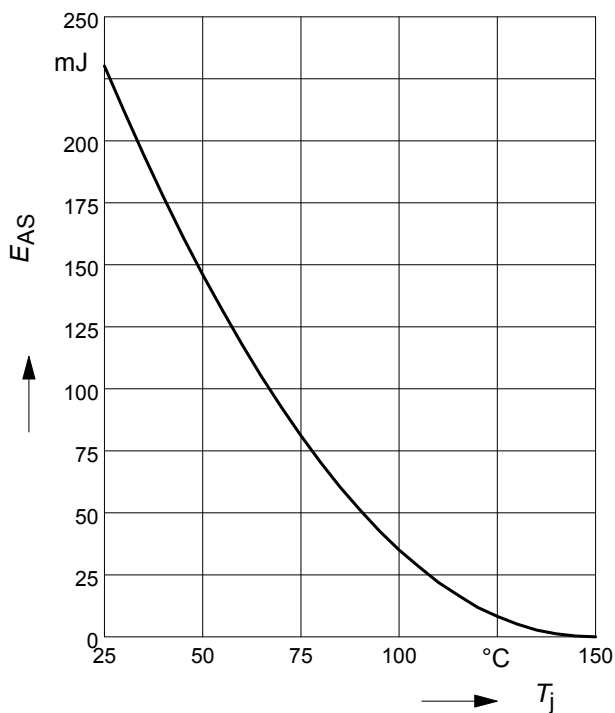

16 Drain-source breakdown voltage

$$V_{(BR)DSS} = f(T_j)$$

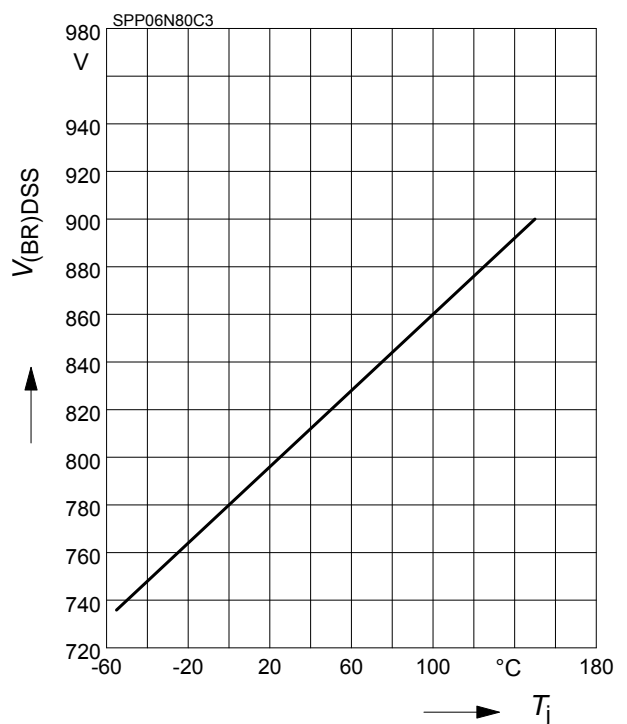

17 Avalanche power losses

$$P_{AR} = f(f)$$

parameter: $E_{AR}=0.2\text{mJ}$

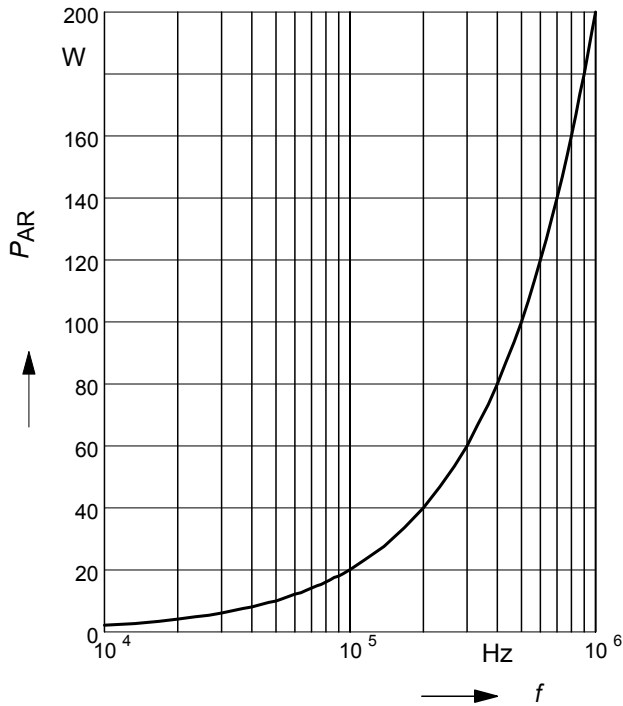

18 Typ. capacitances

$$C = f(V_{DS})$$

parameter: $V_{GS}=0\text{V}$, $f=1\text{ MHz}$

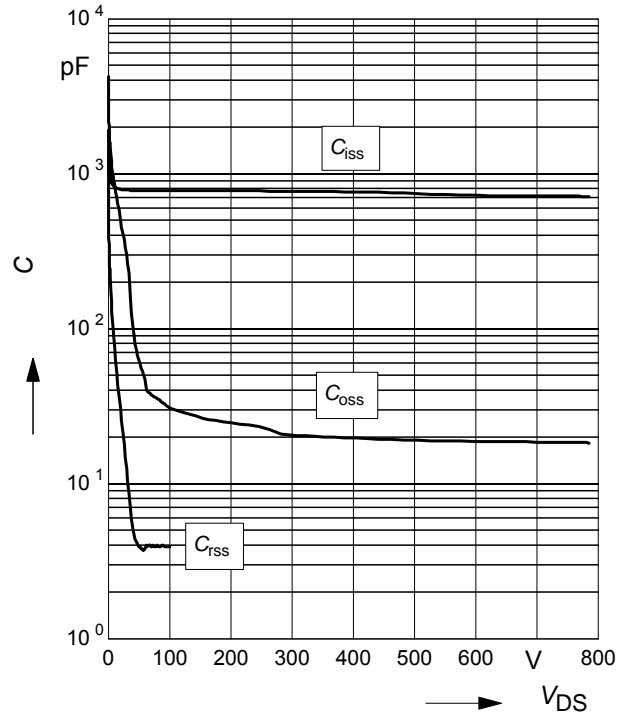

19 Typ. C_{oss} stored energy

$$E_{oss} = f(V_{DS})$$

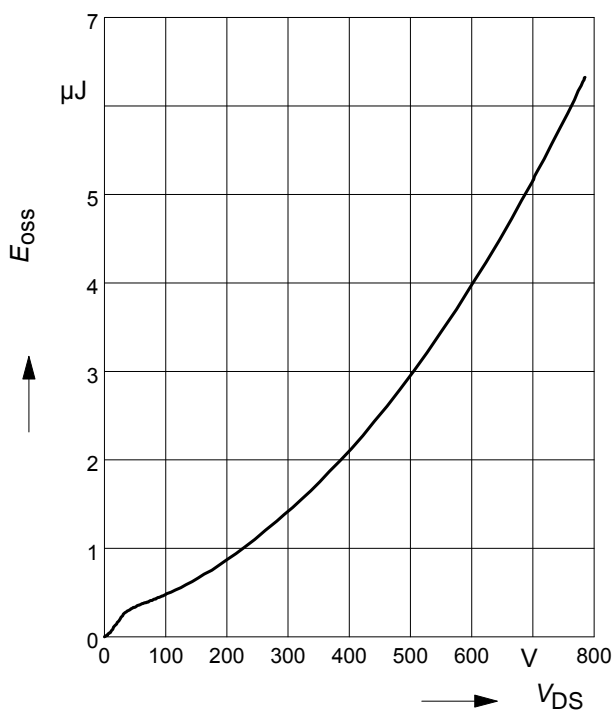

Definition of diodes switching characteristics



PG-TO220-3-1, PG-TO220-3-21

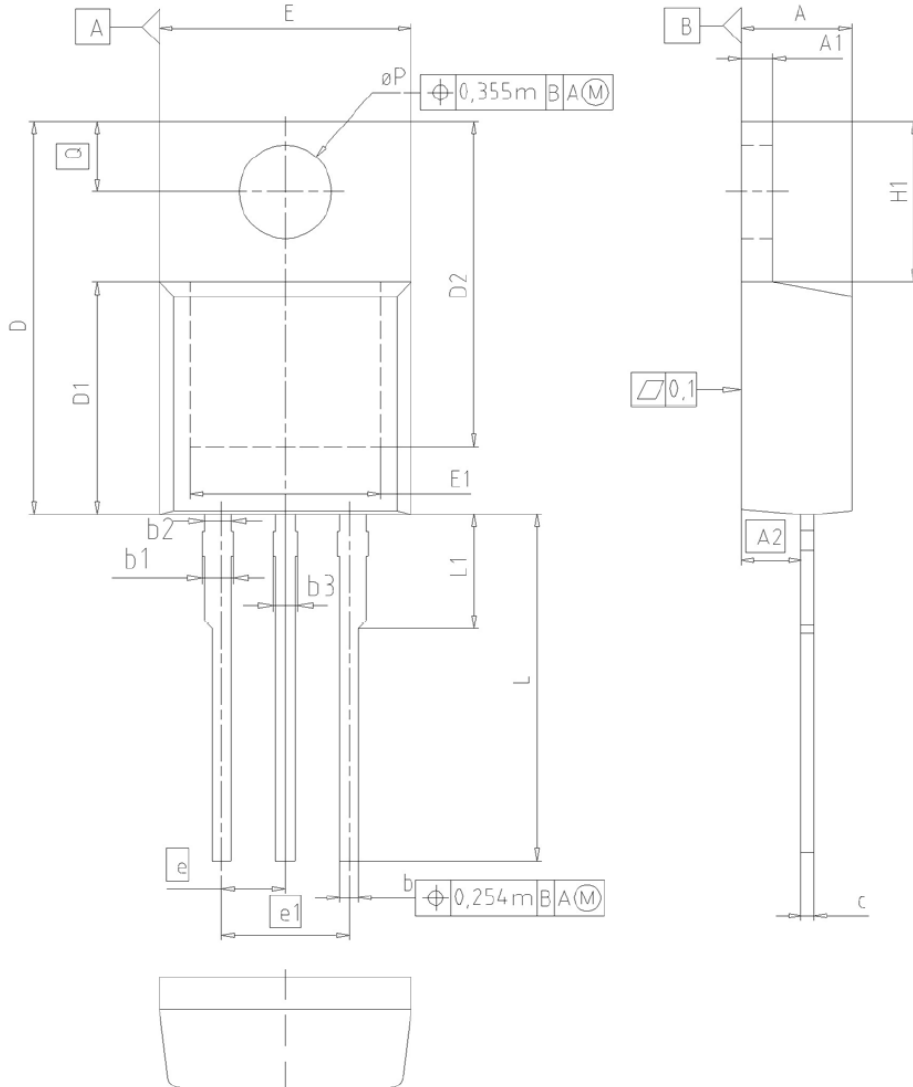

DIM	MILLIMETERS		INCHES	
	MIN	MAX	MIN	MAX
A	4.30	4.57	0.169	0.180
A1	1.17	1.40	0.046	0.055
A2	2.15	2.72	0.085	0.107
b	0.65	0.86	0.026	0.034
b1	0.95	1.40	0.037	0.055
b2	0.95	1.15	0.037	0.045
b3	0.65	1.15	0.026	0.045
c	0.33	0.60	0.013	0.024
D	14.81	15.95	0.583	0.628
D1	8.51	9.45	0.335	0.372
D2	12.19	13.10	0.480	0.516
E	9.70	10.36	0.382	0.408
E1	6.50	8.60	0.256	0.339
e	2.54		0.100	
e1	5.08		0.200	
N	3		3	
H1	5.90	6.90	0.232	0.272
L	13.00	14.00	0.512	0.551
L1	-	4.80	-	0.189
ϕP	3.60	3.89	0.142	0.153
Q	2.60	3.00	0.102	0.118

DOCUMENT NO.
Z8B00003318

SCALE

EUROPEAN PROJECTION

ISSUE DATE
23-08-2007

REVISION
05

PG-TO220-3-31 (FullPAK)

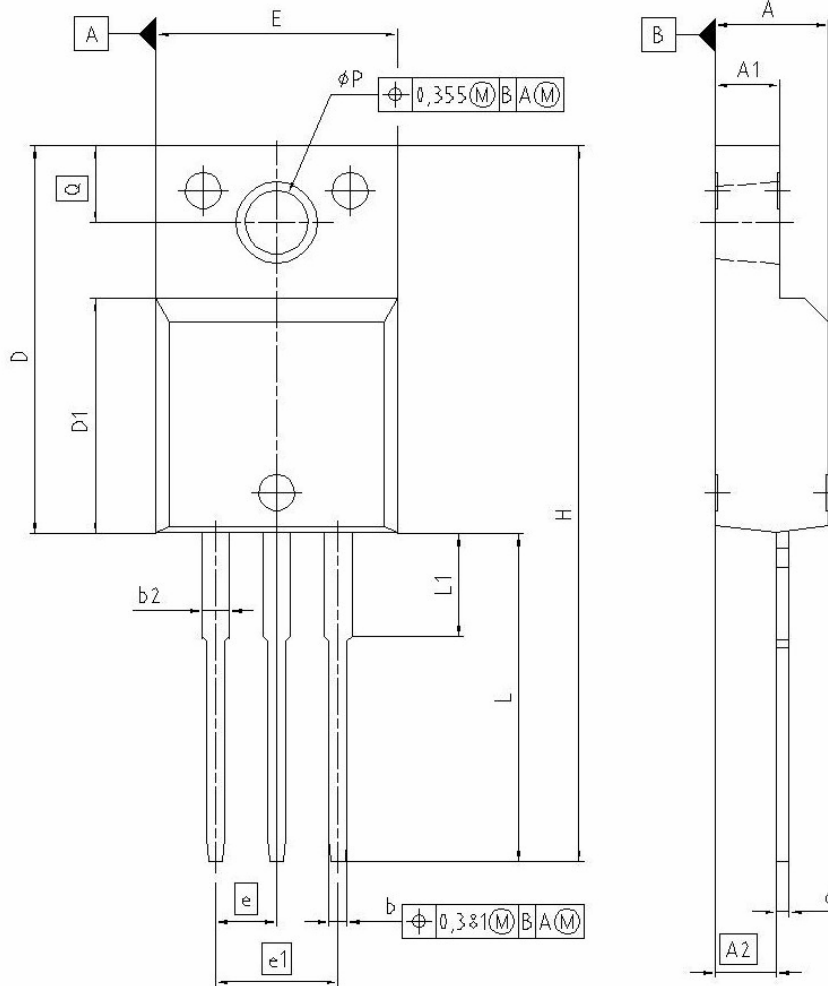

DIM	MILLIMETERS		INCHES	
	MIN	MAX	MIN	MAX
A	4.572	4.826	0.180	0.190
A1	2.573	2.827	0.101	0.111
A2	2.514	2.616	0.099	0.103
b	0.649	0.776	0.025	0.030
b2	1.143	1.509	0.045	0.059
c	0.449	0.627	0.017	0.027
D	15.863	16.117	0.624	0.634
D1	9.554	9.808	0.376	0.386
E	10.373	10.627	0.408	0.418
e	2.540		0.100	
e1	5.080		0.200	
N	3		3	
H	29.463	29.717	1.160	1.170
L	13.473	13.727	0.530	0.540
L1	3.175	3.429	0.125	0.135
φP	2.949	3.025	0.119	0.116
Q	3.149	3.251	0.124	0.128

REFERENCE
J..

SCALE

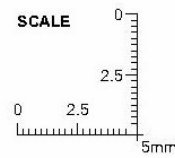

EUROPEAN PROJECTION

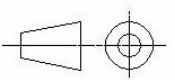

ISSUE DATE
17-08-2005

FILE
TO220_2

Published by
Infineon Technologies AG,
Bereichs Kommunikation
St.-Martin-Strasse 53,
D-81541 München
© Infineon Technologies AG 1999
All Rights Reserved.

Attention please!

The information herein is given to describe certain components and shall not be considered as warranted characteristics.

Terms of delivery and rights to technical change reserved.

We hereby disclaim any and all warranties, including but not limited to warranties of non-infringement, regarding circuits, descriptions and charts stated herein.

Infineon Technologies is an approved CECC manufacturer.

Information

For further information on technology, delivery terms and conditions and prices please contact your nearest Infineon Technologies Office in Germany or our Infineon Technologies Representatives worldwide (see address list).

Warnings

Due to technical requirements components may contain dangerous substances.

For information on the types in question please contact your nearest Infineon Technologies Office.

Infineon Technologies Components may only be used in life-support devices or systems with the express written approval of Infineon Technologies, if a failure of such components can reasonably be expected to cause the failure of that life-support device or system, or to affect the safety or effectiveness of that device or system. Life support devices or systems are intended to be implanted in the human body, or to support and/or maintain and sustain and/or protect human life. If they fail, it is reasonable to assume that the health of the user or other persons may be endangered.