



TN16 and TYNx16 Series

STANDARD

16A SCRs

MAIN FEATURES:

Symbol	Value	Unit
$I_{T(RMS)}$	16	A
V_{DRM}/V_{RRM}	600 to 1000	V
I_{GT}	25	mA

DESCRIPTION

The TYN / TN16 SCR Series is suitable for general purpose applications. Using clip assembly technology, they provide a superior performance in surge current capabilities.

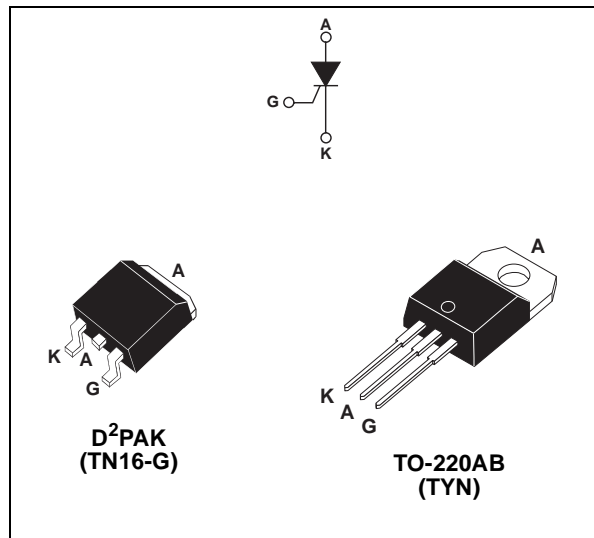

ABSOLUTE RATINGS (limiting values)

Symbol	Parameter		Value	Unit
$I_{T(RMS)}$	RMS on-state current (180° conduction angle)		$T_c = 110^\circ\text{C}$ 16	A
$T_{(AV)}$	Average on-state current (180° conduction angle)		$T_c = 110^\circ\text{C}$ 10	A
I_{TSM}	Non repetitive surge peak on-state current	$t_p = 8.3 \text{ ms}$	$T_j = 25^\circ\text{C}$ 200	A
		$t_p = 10 \text{ ms}$		
I^2t	I^2t Value for fusing	$t_p = 10 \text{ ms}$	$T_j = 25^\circ\text{C}$ 180	A^2s
di/dt	Critical rate of rise of on-state current $I_G = 2 \times I_{GT}$, $t_r \leq 100 \text{ ns}$	$F = 60 \text{ Hz}$	$T_j = 125^\circ\text{C}$ 50	$\text{A}/\mu\text{s}$
I_{GM}	Peak gate current	$t_p = 20 \mu\text{s}$	$T_j = 125^\circ\text{C}$ 4	A
$P_{G(AV)}$	Average gate power dissipation		$T_j = 125^\circ\text{C}$ 1	W
T_{stg} T_j	Storage junction temperature range Operating junction temperature range		- 40 to + 150 - 40 to + 125	$^\circ\text{C}$
V_{RGM}	Maximum peak reverse gate voltage		5	V

TN16 and TYNx16 Series

ELECTRICAL CHARACTERISTICS (T_j = 25°C, unless otherwise specified)

Symbol	Test Conditions			Value	Unit	
I _{GT}	V _D = 12 V R _L = 33 Ω		MIN.	2	mA	
			MAX.	25		
V _{GT}			MAX.	1.3	V	
V _{GD}	V _D = V _{DRM} R _L = 3.3 kΩ	T _j = 125°C	MIN.	0.2	V	
I _H	I _T = 500 mA Gate open		MAX.	40	mA	
I _L	I _G = 1.2 × I _{GT}		MAX.	60	mA	
dV/dt	V _D = 67 % V _{DRM} Gate open	T _j = 125°C	MIN.	500	V/μs	
V _{TM}	I _{TM} = 32 A t _p = 380 μs	T _j = 25°C	MAX.	1.6	V	
V _{t0}	Threshold voltage		T _j = 125°C	MAX.	0.77	V
R _d	Dynamic resistance		T _j = 125°C	MAX.	23	mΩ
I _{DRM} I _{RRM}	V _{DRM} = V _{RRM}		T _j = 25°C	MAX.	5	μA
			T _j = 125°C		2	mA

THERMAL RESISTANCES

Symbol	Parameter		Value	Unit	
R _{th(j-c)}	Junction to case (DC)		1.1	°C/W	
R _{th(j-a)}	Junction to ambient (DC)		TO-220AB	60	°C/W
			S = 1 cm ²	D ² PAK	

S = Copper surface under tab

PRODUCT SELECTOR

Part Number	Voltage (xxx)			Sensitivity	Package
	600 V	800 V	1000 V		
TN1625-xxxG	X	X	X	25 mA	D ² PAK
TYNx16	X	X	X	25 mA	TO-220AB

ORDERING INFORMATION

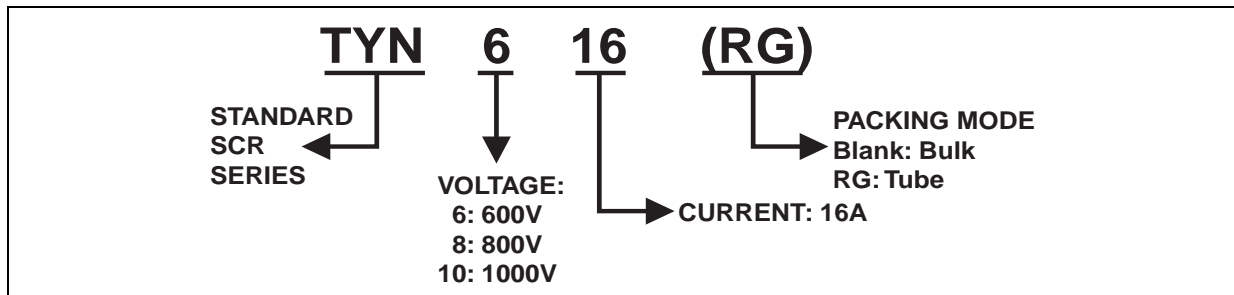
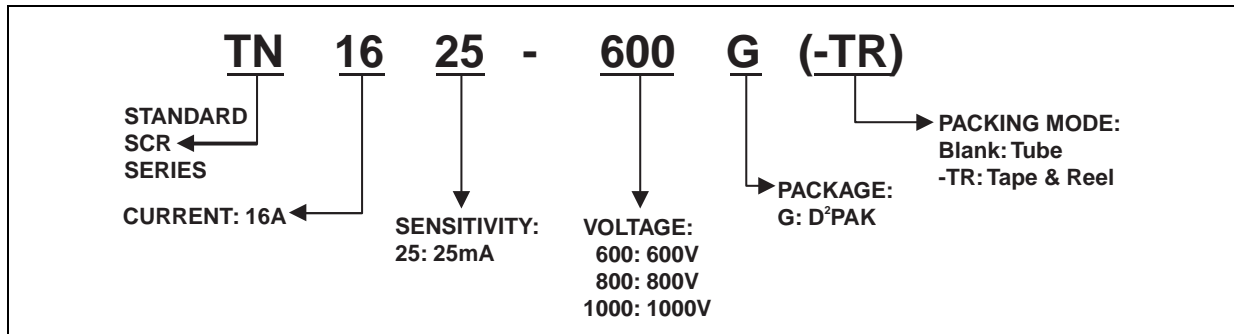

OTHER INFORMATION

Part Number	Marking	Weight	Base Quantity	Packing mode
TN1625-x00G	TN1625x00G	1.5 g	50	Tube
TN1625-x00G-TR	TN1625x00G	1.5 g	1000	Tape & reel
TYNx16	TYNx16	2.3 g	250	Bulk
TYNx16RG	TYNx16	2.3 g	50	Tube

Note: x = voltage

Fig. 1: Maximum average power dissipation versus average on-state current.

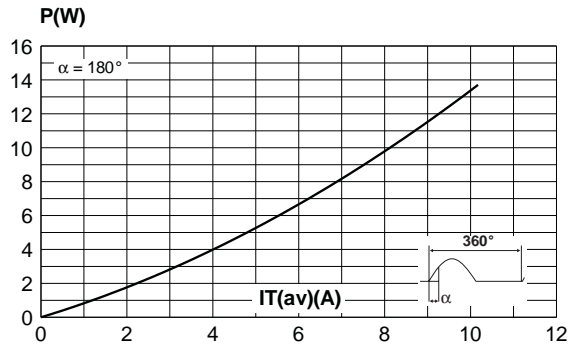

Fig. 2-1: Average and D.C. on-state current versus case temperature.

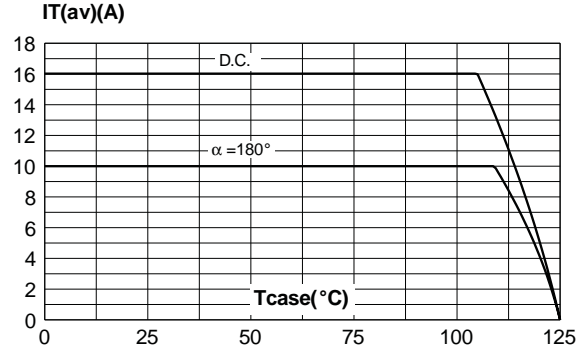

Fig. 2-2: Average and D.C. on-state current versus ambient temperature (copper surface under tab: S = 1 cm² for D²PAK).

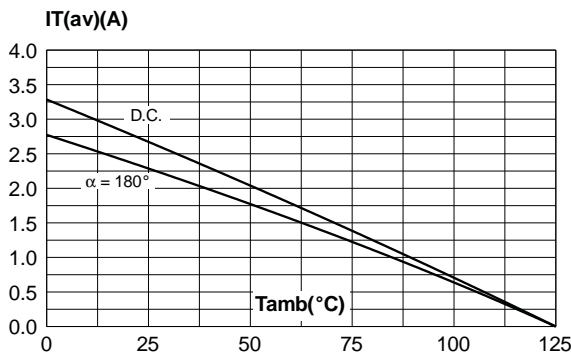

Fig. 3: Relative variation of thermal impedance versus pulse duration.

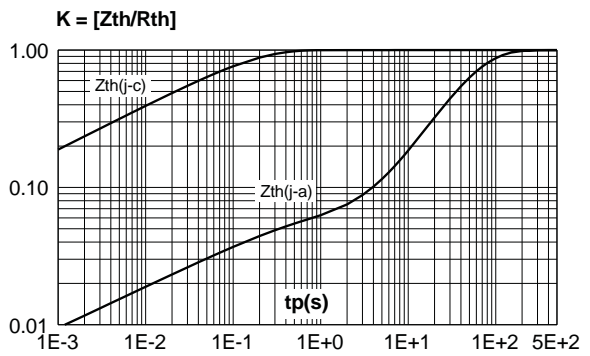

Fig. 4: Relative variation of gate trigger current, holding current and latching current versus junction temperature.

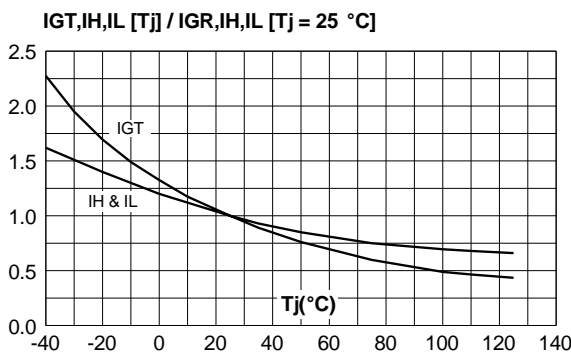

Fig. 5: Surge peak on-state current versus number of cycles.

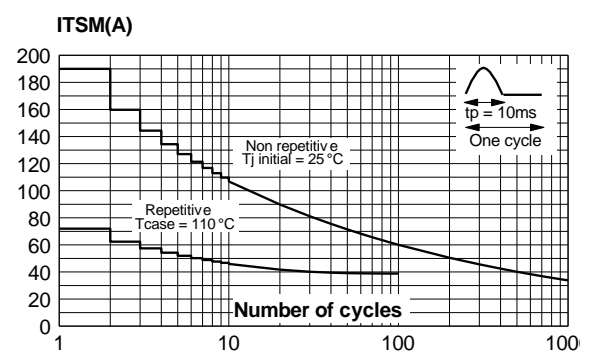

Fig. 6: Non-repetitive surge peak on-state current for a sinusoidal pulse with width $t_p < 10$ ms, and corresponding value of I^2t .

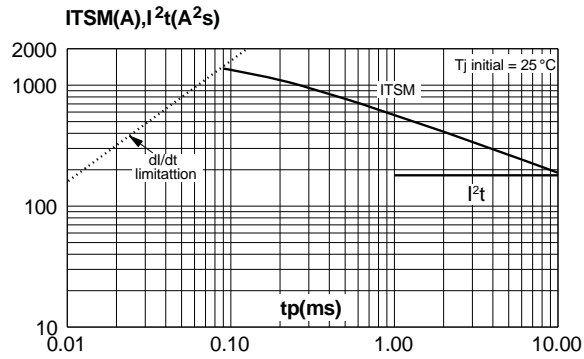

Fig. 7: On-state characteristics (maximum values).

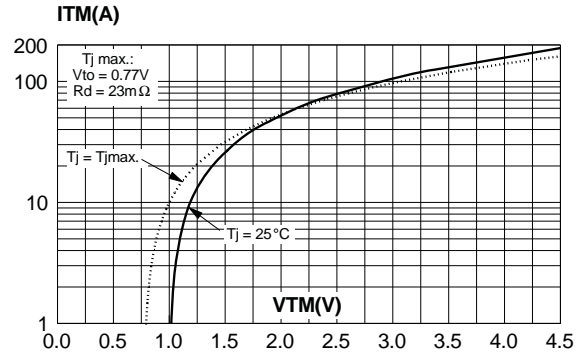
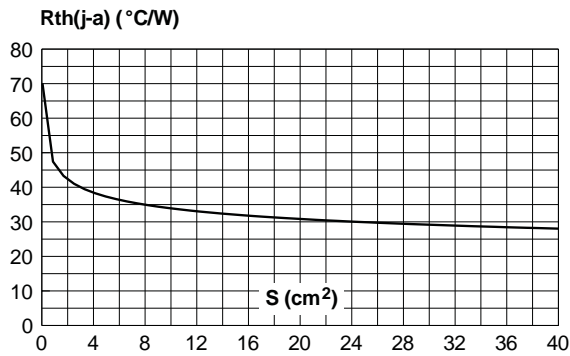

Fig. 8: Thermal resistance junction to ambient versus copper surface under tab (Epoxy printed circuit board FR4, copper thickness: 35 μ m) (for D²PAK).



TN16 and TYNx16 Series

PACKAGE MECHANICAL DATA

D²PAK (Plastic)

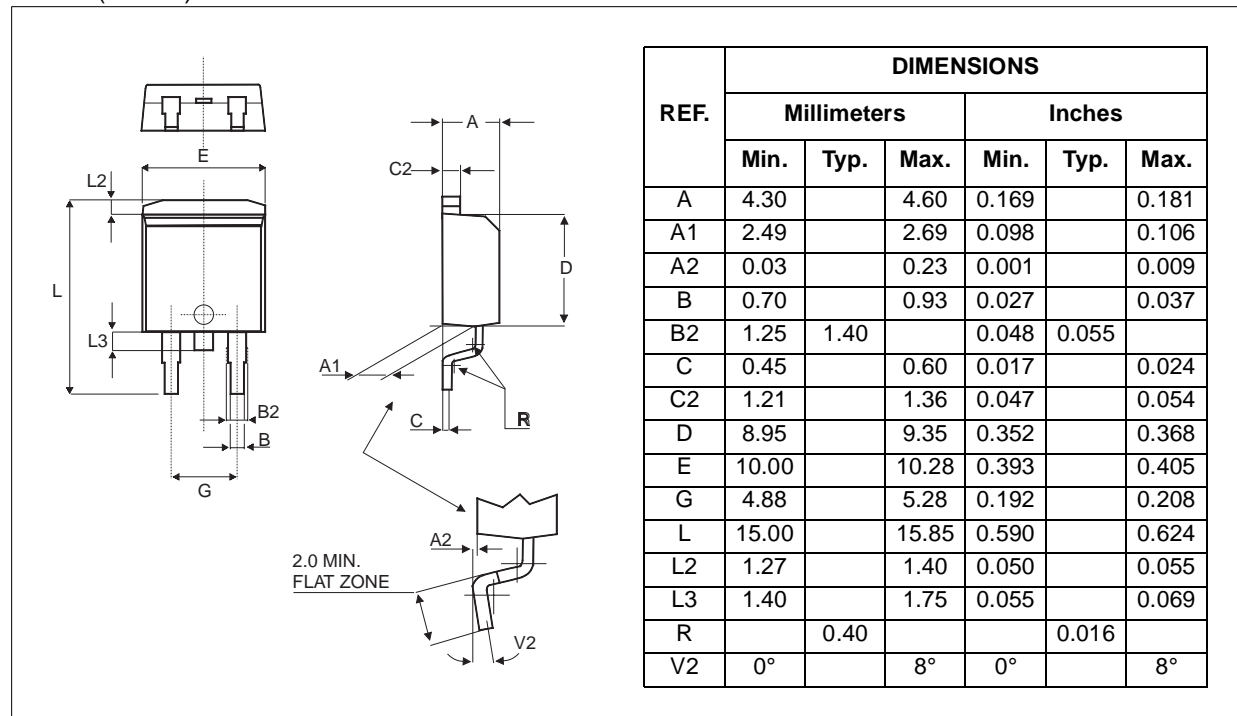

FOOTPRINT DIMENSIONS (in millimeters)

D²PAK (Plastic)

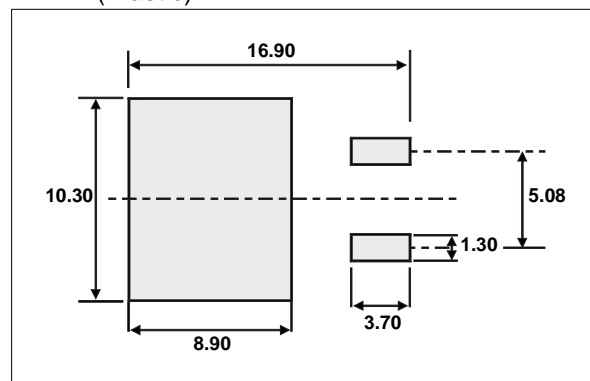

PACKAGE MECHANICAL DATA

TO-220AB (Plastic)

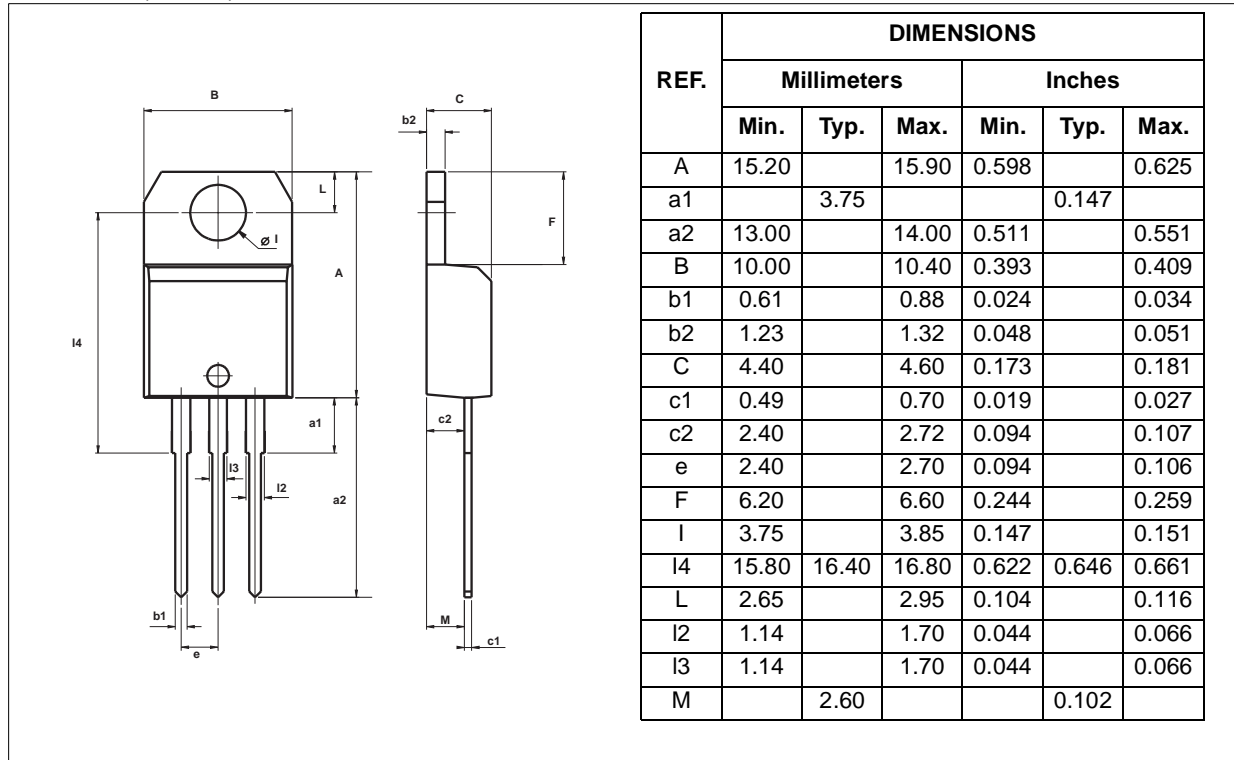

Information furnished is believed to be accurate and reliable. However, STMicroelectronics assumes no responsibility for the consequences of use of such information nor for any infringement of patents or other rights of third parties which may result from its use. No license is granted by implication or otherwise under any patent or patent rights of STMicroelectronics. Specifications mentioned in this publication are subject to change without notice. This publication supersedes and replaces all information previously supplied. STMicroelectronics products are not authorized for use as critical components in life support devices or systems without express written approval of STMicroelectronics.

© The ST logo is a registered trademark of STMicroelectronics

© 2002 STMicroelectronics - Printed in Italy - All Rights Reserved

STMicroelectronics GROUP OF COMPANIES
 Australia - Brazil - Canada - China - Finland - France - Germany
 Hong Kong - India - Isreal - Italy - Japan - Malaysia - Malta - Morocco - Singapore
 Spain - Sweden - Switzerland - United Kingdom - United States.

<http://www.st.com>

